

C.B. 40-CHANNEL TRANSCEIVER

TRC-422A



OWNER'S MANUAL

PLEASE READ BEFORE
USING THIS EQUIPMENT

REALISTIC[®]



**Cat No.
21-1503**

CUSTOM MANUFACTURED FOR RADIO SHACK  A DIVISION OF TANDY CORPORATION

Your **REALISTIC**[®] TRC-422A is a compact 2-way 40-channel radio designed for Class D CB Mobile operation. Though small in size, it is big in performance.

It is a quality piece of electronic equipment, skillfully constructed from the finest components. The circuitry is all solid-state, mounted on rugged printed circuit boards. It is designed for many years of reliable, trouble-free performance.

Your TRC-422A has a built-in 40-channel PLL synthesizer circuit. The Phase Lock Loop is a new technique for generating all the required frequencies with single crystal. The result is much tighter frequency control and superior reliability.

FEATURES

- *Monolithic crystal and ceramic filters for superior selectivity and freedom from adjacent channel interference
- *Bright red LED channel indicator
- *Emergency Switch lets you "jump" to Channel 9 or 19 — instantly
- *Switchable Automatic Noise Limiter (ANL)
- *LED Modulation Indicator helps you tell how fully your voice is modulating the Transmit carrier
- *Hysteresis-type Squelch circuit automatically compensates for signal fading to eliminate signal "chopping" during message reception
- *Extremely sensitive front end circuitry with two-stage Automatic Gain Control for superior reception of weak and strong signals
- *Public Address capability — just add an optional PA speaker
- *Three-way CB-PA-MONitor switch
- *Signal Strength/RF Output Power Meter
- *Dynamic Communications Microphone with locking connector
- *Works in any 12-volt DC system, positive or negative ground
- *Uses 5 ICs, 19 Transistors, 1 FET, 20 Diodes, 1 LED plus two-digit LED display

For your own protection, we urge you to record the Serial Number of this unit in the space provided. You'll find the Serial Number on the back panel of the unit.

Serial Number:

F.C.C. LICENSE (U.S.A.)

Before transmitting with your Transceiver, you must have an FCC Class D Citizens Radio Service License. If you don't have a license yet, you can fill out the Temporary Permit Form 555-B for a temporary license. This enables you to get on-the-air immediately. Also, fill out and mail in FCC Form 505 CB License Application to:

Federal Communications Commission
P.O. BOX 1010
Gettysburg, Penn. 17326

You must also read and know Part 95 of the FCC Rules and Regulations; they apply to the operation of a Class D Citizens Band unit. We've provided a copy of this regulation (along with the forms noted above).

NOTE: Units manufactured for sale in the U.S.A. cannot legally be used in Canada. Canadian models have been D.O.C. approved and carry a D.O.C. approval label with its approval number.

D.O.C. LICENSE (CANADA)

Before transmitting with your Transceiver, you must obtain a Department of Communications (D.O.C.) General Radio Service License. We've provided such an application form with your unit—complete the form and mail with the appropriate fee to the Radio Regulations Office nearest you.

D.O.C. Approval Number: _____

NOTE: Units manufactured for sale and use in Canada are not identical to units type-accepted by the FCC. Canadian models have been approved by D.O.C. and are to be used only in Canada.

BEFORE YOU CALL FOR HELP...

Our repair centers receive many returned products which are actually **working perfectly**. Maybe the owner just didn't read the instructions, or overlooked something. Or perhaps the problem was a blown fuse that the owner could easily have replaced.

So read this manual carefully and be sure **you** understand all the basic features of this CB — and the special ones, too! And before you assume your Transceiver needs repair, refer to the Service and Maintenance section of this manual, to see if the problem is something **you** can eliminate.

Enjoy your Realistic TRC-422A!

SPECIFICATIONS

RECEIVER

Frequency Coverage:	All 40 CB Channels (Class D) 26.965 to 27.405 MHz
Sensitivity:	0.5 μ V or better for 10 dB S + N/N
Adjacent Channel Rejection:	80 dB (at 10 kHz), greater than 100 dB at 20 kHz
Intermediate Frequency:	1st IF = 10.695 MHz 2nd IF = 455 kHz
Audio Output:	6 watts (max)
Frequency Response:	450 — 2500 Hz
Cross-Modulation:	60 dB (or better)
Squelch:	Adjustable from 0.6 μ V to 1 mV

TRANSMITTER

Frequency Coverage:	All 40 CB Channels (Class D) 26.965 to 27.405 MHz
RF Power Output:	4 watts (maximum)
Emission:	8A3
Modulation Capability:	90 — 100%
Spurious Radiation:	70 dB
Frequency Tolerance:	Better than 0.002%
Antenna Impedance:	50 ohms
Current Drain (13.8 volt supply):	1200 mA (without modulation) 1800 mA (full modulation)

PUBLIC ADDRESS

Output Power:	6 watts (maximum)
Output at 10% Distortion:	5 watts
Mic. Sensitivity for 4W Output Power (PA mode):	3 mV (at 1 kHz)
Frequency Response + / - 6 dB:	450 — 2500 Hz

POWER REQUIREMENTS: 12 — 16 volts DC positive or negative ground

DIMENSIONS: 2-7/32" x 5-21/32" x 9-29/32"
(5.6cm x 14.4cm x 25.2cm) HWD

WEIGHT: 2 lbs. 14 ozs. (1.3 Kg)

CONTROLS AND THEIR FUNCTIONS

Front Panel

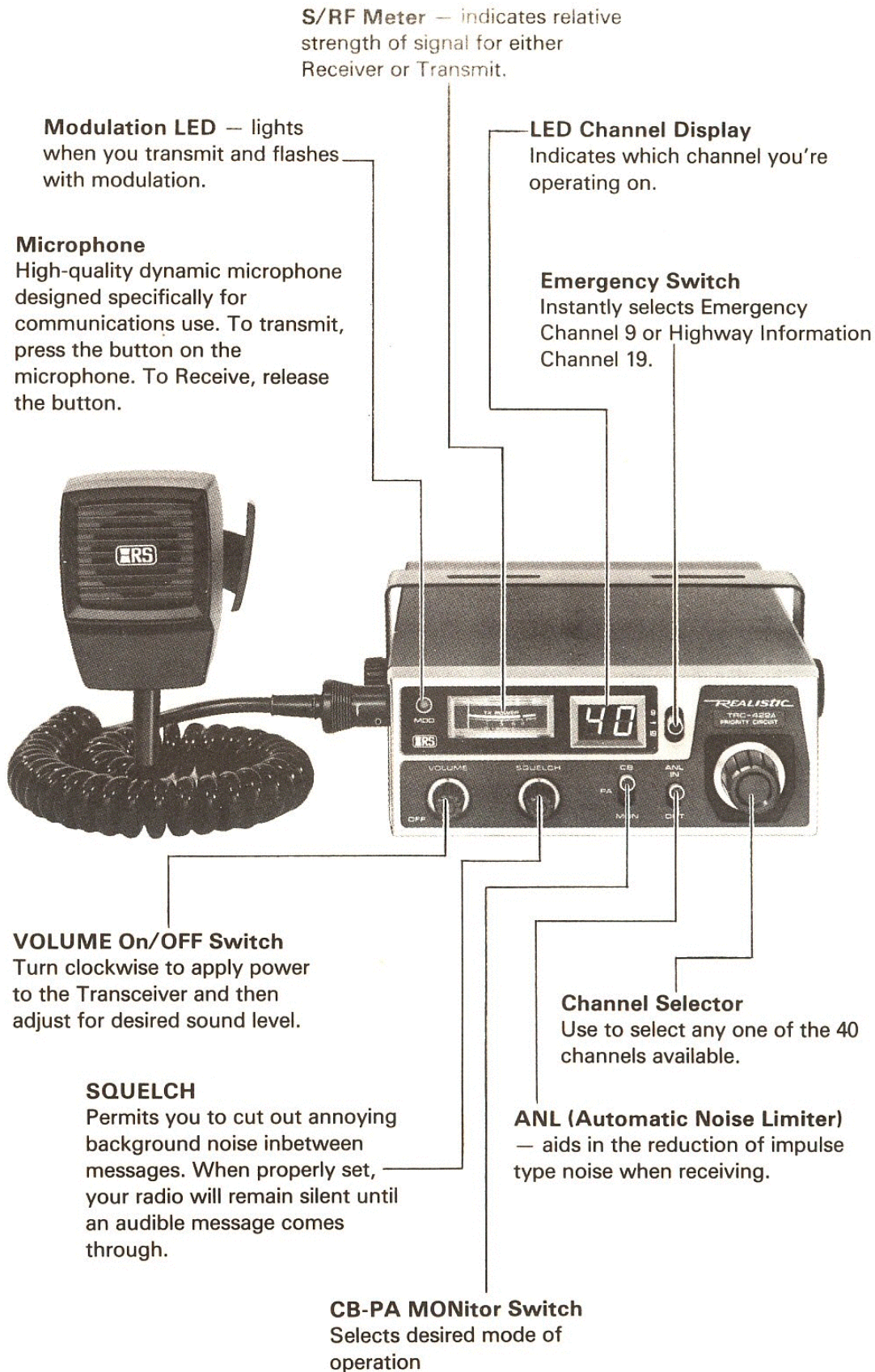

Rear Panel

Public Address SPeaKeR jack
Connect an 8 ohm speaker for PA use.

EXTernal SPeaKeR jack
Connect an external speaker (8 ohm type) to this jack. Connecting an external speaker will automatically disconnect internal speaker. You will need a miniature type phone plug, such as Radio Shack's 274-288, for connection.

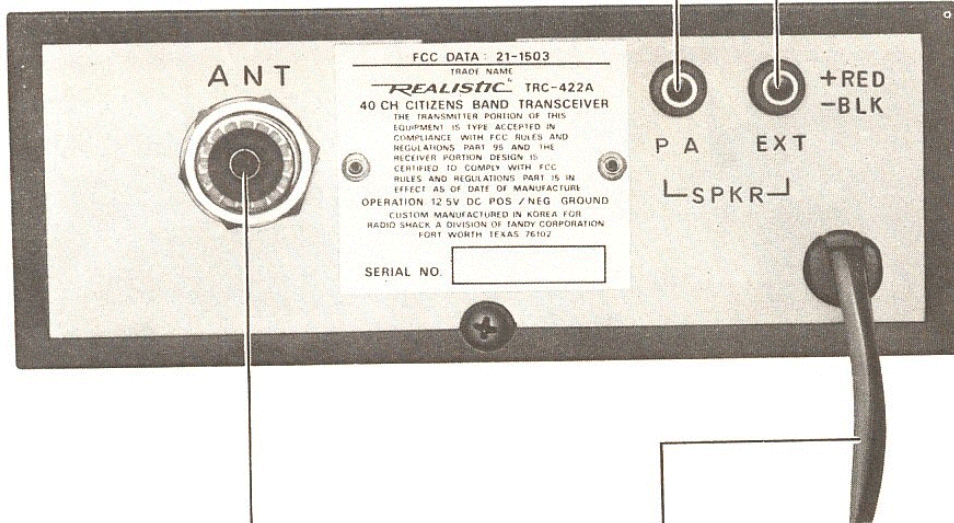

ANTenna Connector
Connect your CB Antenna to this. It accepts a PL-259 male-type coaxial connector.

Power Cables
Connect these cables to a source of 12 volts DC. Connect the Red wire to the + side and the Black wire to the - side.

USING YOUR TRANSCEIVER

Do not Transmit without a suitable antenna or load connected to the ANTenna connector. For Installation, refer to that section.

TO RECEIVE

1. Check that 12 volts is applied to the Transceiver (through the in-line fuse and red wire).
2. Check that an antenna is attached.
3. Connect the MIC plug to MIC jack.
4. Set CB-PA-MON Switch to CB position.
5. Set Emergency Switch to the center position.
6. Set **SQUELCH** control to maximum counterclockwise position.
7. Turn power "on" by rotating **VOLUME** clockwise to click "on".
8. Set **Channel Selector** to the desired channel.
9. Adjust **VOLUME** for a suitable listening level.
10. Adjust **SQUELCH** to cut out annoying background noise when no signal is being received. To do this, set **Channel Selector** to a channel where no signals are present (or wait till signals cease on your channel). Then, rotate **SQUELCH** in a clockwise direction to the point where the background noise just stops. Now, when a signal is present, you will hear it, but will not be disturbed by noise on the channel in - between signals.

When properly set, **SQUELCH** will keep the receiver "dead" until a signal comes in on that channel. Do not set **SQUELCH** too high, or weak signals will not be able to "open" the Squelch circuit. To receive the very weak signals, it is best to leave **SQUELCH** set to the minimum position (maximum counterclockwise).

The **SQUELCH** circuit in your Transceiver is a special advanced development. It uses two extra transistors to accomplish a hysteresis action. The result is that when you set **SQUELCH** for a precise signal level, if that signal level fades (increases or decreases in strength), the Squelch circuit will follow this change. With conventional Squelch circuits often a signal which changes strength gets "chopped" by Squelch and you lose a portion of the message; with hysteresis Squelch you get it all.

TO TRANSMIT

1. Select the desired channel of operation.
2. Connect the MIC plug to MIC jack.
3. Press the push-to-talk button on the Microphone and hold it at an angle about 2-3" (5cm - 7.5cm) from your mouth and speak in a normal voice.
4. To Receive, release the push-to-talk button.



Be sure the Mic plug is **firmly** connected to the jack: if the connector starts to loosen up, you may end up with squeal, feedback and many other unusual problems.

NOTE: Shouting into the Mic will not increase your power or signal. An internal circuit automatically sets the mic signal for maximum modulation, so there is no need for loud speech — as a matter of fact, shouting may result in distortion (speech distortion going into the mic).

Emergency Switch

In an emergency you don't want to spend time turning the Channel Selector until you reach the desired channel. So we've incorporated a special switch that puts you on Channel 9 or 19 instantly. Channel 9 has been set aside by the FCC for emergency communications only; Channel 19 is commonly used by truckers and motorists for conveying information on road and traffic conditions, etc.

Set the Emergency Switch to **9** (up) for Channel 9, and to **19** (down) for Channel 19. Move switch to center position to return to previously selected channel.

TO USE PUBLIC ADDRESS FUNCTION

Do not set the CB-PA-MON switch to PA unless an 8-ohm (5 watts or more) speaker is attached to the PA SPKR jack on the rear of the Transceiver.

1. Connect suitable 8 ohm speaker to the **PA SPKR** jack located on the rear.
2. Set the **CB-PA-MON** switch to the PA position.
3. Press and hold the push-to-talk button on the microphone and hold it at an angle about 2–3" (5–7.5 cm) from your mouth and speak in a normal voice.
4. Adjust **VOLUME** for a suitable public address level.
5. If you want to monitor CB incoming calls while you are using the PA function, set **CB-PA-MON** switch to MON position. This way you won't miss important CB calls (you'll hear them through the PA speaker).

Important: Always face the PA SPEAKER away from the microphone and as far possible from the unit to prevent feedback (high-pitched howling sounds).

REMOTE SPEAKER OPERATION

An 8 ohm 3–10 watt speaker should be used for this function. Plug the speaker into the **EXT. SPKR** jack at the rear of the Transceiver. When the external speaker is plugged in, the internal speaker is disconnected. You can now monitor all incoming signals through your remote speaker.

Summary of Operating Modes

Push-to-talk switch CB-PA- MON switch	EXT/PA SPKR Jack Connection							
	No Connection		EXT SPKR		PA SPKR		EXT & PA SPKR	
	Release	Hold	Release	Hold	Release	Hold	Release	Hold
CB	Internal Speaker (CB)	Transmit	EXT Speaker (CB)	Transmit	Internal Speaker (CB)	Transmit	EXT Speaker (CB)	Transmit
PA	No Output	No Output	No Output	No Output	No Output	PA Speaker (PA)	No Output	PA Speaker (PA)
MON	No Output	No Transmit	No Output	No Transmit	PA Speaker (CB)	PA Speaker (PA)	PA Speaker (CB)	PA Speaker (PA)

Note: When CB-PA-MON switch is in PA position, indication of LED display is "OFF". But when CB-PA-MON switch is in MON position, LED display indicates channel number selected.

CONNECTING THE LOCKING MIC PLUG

Your Transceiver features a new locking microphone connector. This insures that you won't accidentally pull out or loosen the plug connection (when extending the MIC cable while moving about).

To connect the MIC plug:

Press the small tab on the side and insert plug into jack, taking care to align the plug and jack properly. See Figure 1A.

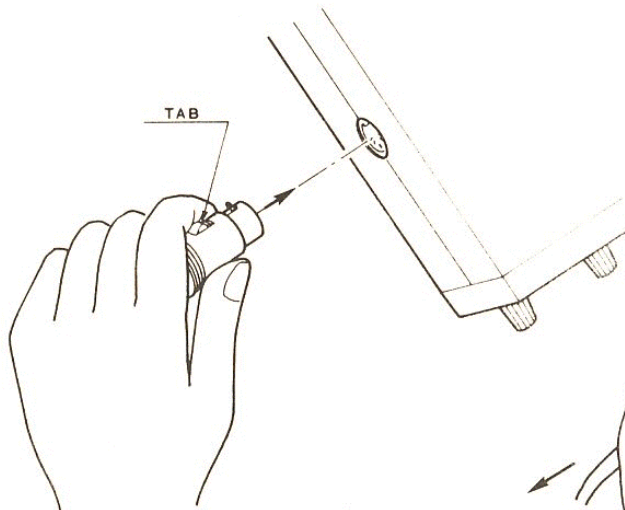

Figure 1A

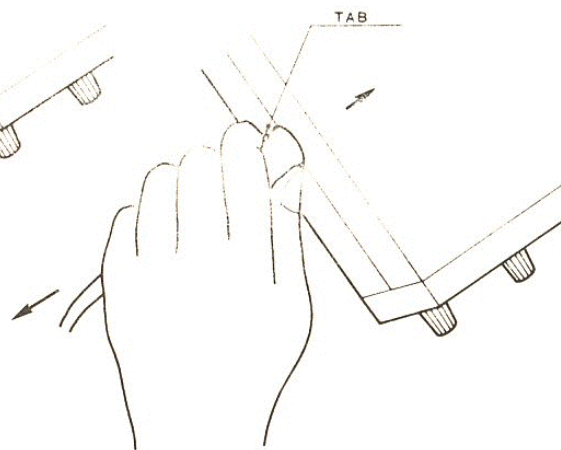

Figure 1B

To release the MIC plug:

You must press the small tab on the side, push plug in to release lock and then pull out. See Figure 1B.

Note: To hear receiver's sound, you must have the Mic connected.

TO GET THE MOST OUT OF YOUR TRANSCEIVER...

We've provided a few extra features that will enhance your operation.

The **ANL** switch adds an Automatic Noise Limiter circuit which helps to reduce or eliminate low-level impulse-type external noise. If you don't need this circuitry, leave switch in the OUT position.

The **S/RF Meter** gives you a relative indication of RF output power when you are transmitting (upper scale — any reading in the red area means you have full legal output). When receiving, the meter shows the relative strength of the incoming signal (lower scale — in "S" units).

The **Modulation LED** will light up when you transmit. Degree of brilliance will vary with your voice level. It will be at maximum brilliance when you achieve 100% modulation.

A Remote External Speaker connected to the **EXT SPKR** jack on the back will give you added versatility. When you plug a miniature jack into this connector, the internal speaker will be disconnected. Radio Shack sells a number of fine speakers for Remote/Extension CB use.

SOME HINTS TO HELP YOU ENJOY YOUR C.B.

- Wait for a pause in transmission before asking for a Break.
- If you don't receive an answer after a second call to another station, sign off and allow others to use the channel — wait a while, ask for a break and try again.
- Do not Dead Key (hold transmitter button in).
- Assist callers with directions, road conditions or other requested information.
- Keep harassment off the air. This is unnecessary and causes problems for everyone, including you.
- Be courteous — treat others the way you wish to be treated.

INSTALLATION

Safety and convenience are the primary considerations for mounting any piece of mobile equipment. All controls must be readily available to the operator without interfering with the movements necessary for safe operation of the vehicle. Be sure all cables are clear of the brake, clutch and accelerator. Also, thought must be given to the convenience of passengers (for example, will they have adequate leg room?).

Another extremely important requirement is the ease of installation and removal (for service and maintenance). Mount the Transceiver so it can be slipped in and out very easily.

The most common mounting position for a Transceiver is under the dashboard directly over the driveshaft hump. Do not mount the Transceiver in the path of the heater or airconditioning air stream.

When you have determined the best location for mounting, use the Mounting Bracket as a template to mark mounting holes. Take care when you drill holes that you do not drill into wiring, trim or other accessories. Mount in position with bolts, lockwashers and nuts or self-threading screws. Refer to Figure 2 for mounting illustration.

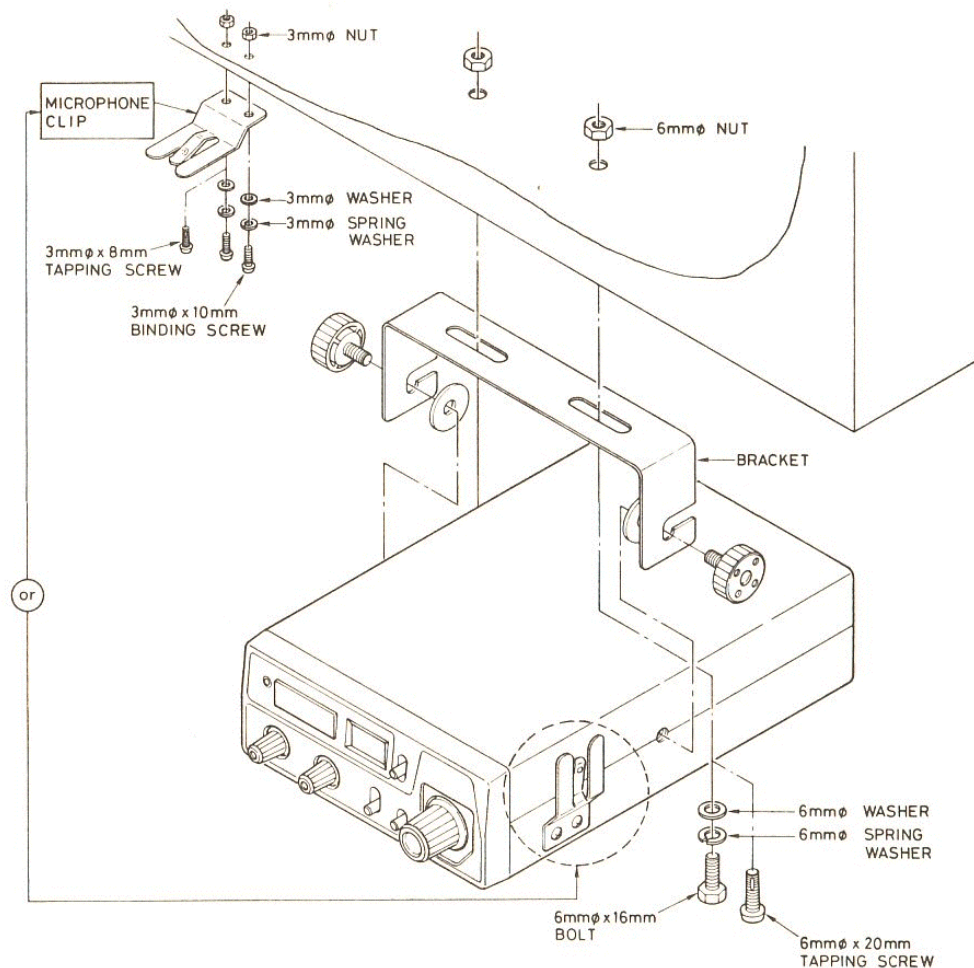

Figure 2

INSTALLATION (CONT.)

You can install this Transceiver in any location where 12 volts DC power is available. It can be connected to either positive or negative ground systems. Just be sure you connect the Red wire to the plus (+) terminals and the Black wire to the minus (–) terminal.

With Negative Ground

Connect the Red wire (with in-line fuse holder) to the Accessory terminal on the ignition switch of your vehicle. Make a good mechanical and electrical connection to the frame of the vehicle for the Black (negative) wire.

With Positive Ground

Connect the Black wire to the Accessory terminal of the ignition switch. Connect the Red wire (with in-line fuse holder) to the frame of the vehicle.

You can use an auto accessory plug (Radio Shack Catalog Number 274-331) to connect your transceiver to the vehicle's cigarette lighter plug. However, it is better to connect the DC power cord directly to the accessory terminal of the ignition switch. This will prevent unauthorized use of the Transceiver, and will also prevent you from leaving it on unintentionally.

Connect the Antenna system to the **ANTenna** coax connector. If you are using an external speaker connect it to the **EXT SPKR** jack.

CITIZENS BAND FREQUENCY CHART

CHANNEL	FREQUENCY	CHANNEL	FREQUENCY
1	26.965	21	27.215
2	26.975	22	27.225
3	26.985	23	27.255
4	27.005	24	27.235
5	27.015	25	27.245
6	27.025	26	27.265
7	27.035	27	27.275
8	27.055	28	27.285
9	27.065	29	27.295
10	27.075	30	27.305
11	27.085	31	27.315
12	27.105	32	27.325
13	27.115	33	27.335
14	27.125	34	27.345
15	27.135	35	27.355
16	27.155	36	27.365
17	27.165	37	27.375
18	27.175	38	27.385
19	27.185	39	27.395
20	27.205	40	27.405

ANTENNA SYSTEM

A mobile antenna system is not limited to the antenna itself; both the transmission line and the vehicle are important factors in the total antenna system. Therefore you must use the correct type of transmission line and mount the antenna securely in a position that gives optimal results (more on this later).

Use coaxial cable with an impedance of 50 ohms. We suggest type RG-58/U for lengths under 100' (30 m), or RG-8/U for longer lengths. Generally speaking, you should keep the length of the transmission line to a minimum.

An SWR (Standing Wave Ratio) Meter can help you gauge the efficiency of your antenna system (how well it is matched to the Transceiver). Radio Shack carries several meters for measuring SWR, RF output power, etc.

The above discussion is as important for reception as it is for transmission. If a mismatch exists between the antenna and the receiver, the excellent sensitivity and signal-to-noise ratio of the receiver circuitry will be defeated.

MOBILE ANTENNAS

A few general rules should help you install any mobile antenna properly.

1. Keep it as far as possible from the main bulk of the vehicle.
2. Keep as much of it as possible above the highest point of the vehicle or boat.
3. During operation, it must be vertical. Thus, it should be mechanically rigid so it will remain vertical when the vehicle or boat is in motion.
4. Mount it as far as possible from sources of noise (ignition system, gauges, etc.) and keep the transmission line away from these noise sources.

An antenna mounted in a boat requires a ground. This can be either a metal hull or a ground made of tin-foil or copper sheeting. This ground should cover an area of 12 square feet (1 m²) or more. Be sure the Transceiver also has an adequate ground. Our Catalog Number 21-912 has been designed so no additional ground is needed, so if you use this antenna it will save you an extra bit of work.

MOBILE ANTENNAS (CONT.)

There are two types of mobile CB antennas: a full-length whip or loaded whip. Your local Radio Shack store has a complete line of both types and the salesperson can help you choose the best antenna for your needs.

A vertically polarized whip antenna is best suited for mobile service. It is omni-directional and can be the loaded type or a full quarter-wave (quarter-wave being more efficient).

There are many possible antenna locations on a car. Four of the most popular are shown and discussed below.

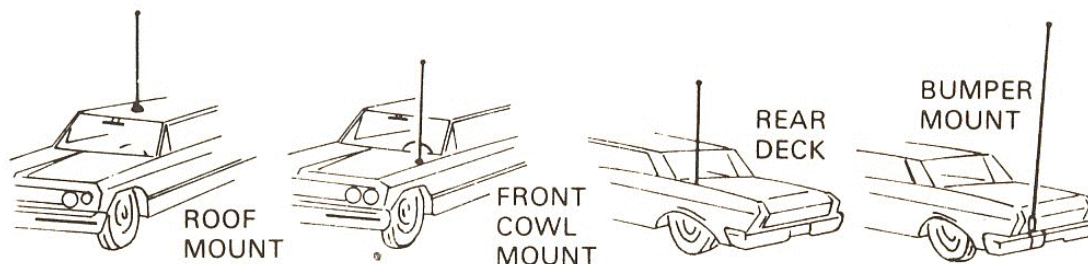

ROOF MOUNT — In this position the antenna radiates equally in all directions. Since the normal $\frac{1}{4}$ wavelength whip antenna is too long (102'' or 2.6 m) for roof mounting on a vehicle, the antenna is shortened and a loading coil is used to provide the proper electrical length. Our Fiberglass Roof-Mount Catalog Number 21-925, is a good durable antenna.

FRONT COWL MOUNT — The radiation pattern is slightly greater in the direction of the rear fender opposite the side on which the antenna is mounted. However, this position offers a number of advantages. The CB antenna can be easily mounted. It can double as both the CB and the standard auto radio antenna by employing a two-way coupler. Ask about our Catalog Number 21-930 Front Cowl Mount antenna which is designed for CB, AM and FM operation.

REAR DECK — The radiation pattern is strongest in the direction of the front fender opposite the side on which the antenna is mounted. In this position you can use a full quarter-wave antenna or a shorter, loaded whip. Here you might consider Radio Shack Catalog Number 21-926 or 21-908, or one of the full 102'' (2.6m) whips.

BUMPER MOUNT — The antenna radiates in a pattern directly in front of and to the rear of the vehicle, with maximum radiation directly away from the vehicle, in a horizontal plane. Despite its fairly irregular pattern, a bumper mounted full-length whip antenna will normally give the best results. Removing the antenna is simple and will leave no holes in the car. We suggest you try our bumper-mount fiberglass whip, Catalog Number 21-927.

BASE STATION ANTENNAS

While your Transceiver is designed for Mobile operation, you might wish to use it for a Base Station unit, in conjunction with a 120 volt AC/12 volt DC Power Supply (available also from Radio Shack). In case you do use your Transceiver in a Base station, here is a very brief discussion about Base Station Antennas.

There are three basic types of base antennas (shown below).

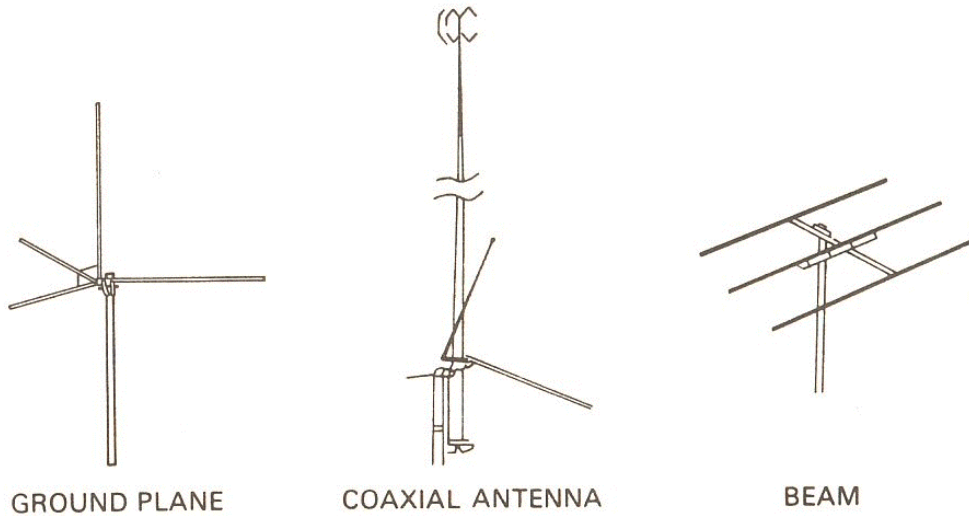

GROUND PLANE COAXIAL ANTENNA BEAM

BASE STATION ANTENNAS

- A. The vertical ground plane antenna is the most popular fixed station antenna. It is omni-directional and provides good performance for contacting other fixed and mobile stations. For medium-long range communications. We suggest Radio Shack 21-901.
- B. The coaxial antenna is a high-efficiency radiator with omni-directional characteristics. It performs as well in most applications as the ground plane. For medium-long range communications. Try 21-902, 21-1133 or 21-964.
- C. The directional beam antenna provides maximum gain and maximum directivity. The directivity can be a disadvantage unless a rotor is used. Since a beam antenna is directional, it greatly reduces noise and interference from all other directions. For long range communications. Check out our 3-Element Beam, 21-933.

The antenna system should be adequately grounded.
Always use a lightning arrester for your antenna system.

For maximum efficiency, we strongly recommend using an SWR meter to aid in the proper matching of your antenna and Transceiver.

Your Radio Shack store carries a complete line of base station CB antennas and accessories.

For more information, we recommend that you obtain a copy of *REALISTIC GUIDE TO CB RADIO*, at your Radio Shack store.

NOISE

In Mobile operation, your vehicle or boat can be the cause of much noise interference. Since the receiver section of your transceiver is very sensitive, it will pick up even the smallest noise signals and amplify them. Any noise that you hear in the Transceiver is almost totally from external sources. The receiver itself is exceptionally quiet.

If the noise is continuous and fairly loud, it cannot be totally eliminated by the Automatic Noise Limiter (ANL) Circuit. You must solve the problem at its source.

To find out if the noise is from your ignition system, try this simple test. Turn off your ignition switch and set it to ACC (accessories). This turns off the ignition, but supplies power to the Transceiver. Most of the noise will probably disappear, indicating that the source of noise is your vehicle's ignition or other electrical systems.

Ignition System

Ignition-type noise can be identified by the fact that it varies with the speed of the engine. It consists of a series of popping sounds. There are a number of things that can be done to reduce this type of noise:

1. Use only the "radio suppression type" high voltage ignition wire. Most new cars come already equipped with this type of wire.
2. Inspect the high voltage ignition wire and all connections made with this wire. Old ignition wire may develop leakage, resulting in hash.
3. If noise still persists, replace the spark plugs with spark plugs that have suppressor resistors built-in. Be sure to use the correct type for your vehicle.

Other sources of noise are: generator/alternator, regulator, gauges and static discharge. Most of these types of noise can be effectively reduced or eliminated by using bypass capacitors at the various output voltage points. We suggest you check your Radio Shack store for a selection of noise reduction accessories.

SERVICE AND MAINTENANCE

Your Transceiver has been built in accordance with Radio Shack's exacting quality control standards. However, it should be treated with reasonable care accorded any electronic equipment. Avoid exposing it to severe shock, dirt or moisture.

If you run into problems with the unit, we recommend you check the following:

1. If trouble is experienced with receiving:
 - Check the **VOLUME ON/OFF** switch setting.
 - Be sure **SQUELCH** is adjusted properly. Is it over-squelched?
 - Check if the unit is switched to an active channel.
 - Be sure the microphone plug is securely in place.
2. If trouble is experienced with transmitting:
 - Check if the transmission line is securely connected to the ANTenna Connector.
 - Check if the antenna is correctly installed for proper operation.
 - Are all transmission line connections secure and free of corrosion?
 - Make sure you are fully pressing the Push-To-Talk Button on the Mic.
 - Be sure Mic connector is firmly pressed into its jack.
 - Check setting of PA-CB-MON switch.
3. If the Transceiver is completely inoperative:
 - Check the power cable and in line fuse.
Replace only with an identical 2 amp fuse.

If these checks don't solve the trouble, do NOT attempt repairs or adjustments yourself. The unit should be serviced only by a qualified radio technician. Whenever possible, return the unit to the store from which it was purchased.

WARNING

Do not open up the Transceiver to make any internal adjustments. Any internal adjustments can be made only by (or under the direct supervision of) a person holding an FCC 1st or 2nd Class Radio Operator's License.

Internal adjustments and/or modifications can lead to illegal operation as defined by FCC Rules and Regulations, Part 95. Such illegal operation can lead to very serious consequences.

TO BE SAFE AND SURE:

1. You should never open up the case of your Transceiver.
2. Never change or replace anything in your Transceiver.

TYPICAL APPLICATIONS FOR YOUR CB TRANSCEIVER

Personal and family:

Keep in touch with home while driving to work, to the store or social activity. Let your family know you're tied up in traffic or that you'll stop by the market on the way home.

If you're a two-car (or more) family, CB is great for communication between members of your family while they are in their cars.

Contact friends and neighbors — find out "what's happening" or plan a get-together. You can even meet new friends this way.

Ever have car trouble or run out of gas on the highway? What an assurance it is to be able to radio for assistance.

Camping, hunting, fishing or other sports are more fun with CB. Locate a buddy or find out "What's cooking back at camp".

Use the PA amplifier for calling companions on outings, at truck stops, etc.

Business Uses:

Call your office or coordinate field employee activities.

Sales and Service people save valuable time and cut down on missing contacts and appointments.

Doctors and Nurses can call their office or hospital to check on important calls or a particular patient.

With Security Policemen 2-way radio is more than a convenience, it's a must for both safety and efficiency.

Truckdrivers and Deliverymen learn road and traffic conditions and obtain assistance in locating destinations. CB is also a lot of company on those "long hauls".

In Construction Crews, CB quickly pays for itself when you're calling for additional materials or coordinating the activities of various work crews:

10-CODES

Citizens band radio operators have largely adopted the 10-codes for standard questions and answers. Its use permits faster communication and better intelligibility in noisy areas. The following table lists some of the more common codes and their meanings.

Code	Meaning	Code	Meaning
10-1	Receiving poorly	10-10	Standing by
10-2	Receiving well	10-13	Advise road/weather conditions.
10-3	Stop Transmitting	10-20	What is your location?
10-4	OK	10-33	Emergency traffic
10-7	Out of Service	10-36	Correct time
10-8	In Service	10-41	Switch to Channel.
10-9	Repeat	10-62	Cannot copy you.

RADIO SHACK LIMITED WARRANTY

This equipment is warranted against defects for 90 days from date of purchase. Within this period, we will repair it without charge for parts and labor. Simply **bring your sales slip** as proof of purchase date to any Radio Shack store. Warranty does not cover transportation costs. Nor does it cover equipment subjected to misuse or accidental damage.

This Warranty gives you specific legal rights and you may also have other rights which vary from state to state.

We Service What We Sell

RADIO SHACK  A DIVISION OF TANDY CORPORATION

U.S.A.: FORT WORTH, TEXAS 76102
CANADA: BARRIE, ONTARIO L4M 4W5

TANDY CORPORATION

AUSTRALIA

280 316 VICTORIA ROAD
RYDALMERE, N S W 2116

BELGIUM

PARC INDUSTRIEL DE NANINNE
5140 NANINNE

U K

BILSTON ROAD WEDNESBURY
WEST MIDLANDS WS10 7JN