

# AM/SSB CB Transceiver

## TRC-490



## OWNER'S MANUAL

PLEASE READ BEFORE  
USING THIS EQUIPMENT

**REALISTIC**<sup>®</sup>

**CAT. NO.  
21-1583**

CUSTOM MANUFACTURED FOR RADIO SHACK  A DIVISION OF TANDY CORPORATION

Your REALISTIC TRC-490 is a completely solid-state AM/SSB Transceiver designed for the Citizens Band Radio Service. It uses a frequency synthesizing circuit with Digital Phase Locked Loop techniques to provide crystal-controlled transmit and receive operation on all 40 channels. The PLL circuitry assures ultra-precise frequency control. You can use your TRC-490 Transceiver on any one of the 40 channels in the conventional AM mode, plus the same 40 channels in either the Upper Single Sideband mode or the Lower Single Sideband mode.

This flexibility not only doubles the effective number of channels from 40 to 80, but SSB also increases the effective range of communication because all the power is concentrated in one sideband to provide 100% talk-power. Single Sideband reception also adds advantages in sensitivity and selectivity, plus lower signal-to-noise. This of course also contributes to an increase in operating range.

The TRC-490 has been carefully designed for ease of operation. You can select AM, Upper Sideband or Lower Sideband with the simple change of a 3-position switch. Transmission is simple too—just press the microphone button. Ordinarily an SSB signal will reach farther and be heard more clearly than an equivalent AM signal. SSB reception is simple—just adjust the CLARIFIER control to bring in the voice transmissions.

We've added all the other most wanted features for optimum communications — RF Gain control, Squelch, Clarifier, PA, switchable Automatic Noise Limiter and Noise Blanker circuits, RF-S meter, Crystal Lattice Filter, Instant Channel 9 button and LED Channel indicator.

The Squelch circuit is a special hysteresis type. This means it is immune to signal fading which often results in squelch "chopping". Another special feature from Radio Shack.

The TRC-490 is designed to operate from 12 volt DC negative or positive ground electrical systems, or from 120 Volt AC power.

For your own protection, we urge you to record the Serial Number of this unit in the space provided. You'll find the Serial Number on the back panel of the unit.

Serial Number

## SPECIFICATIONS

### GENERAL:

<b>Channels</b>	: 40 Channels for AM, Upper Side Band and Lower Side Band, utilizing Digital Circuitry
<b>Frequency Range</b>	: 26.965 MHz to 27.405 MHz
<b>Frequency Control</b>	: Digital (Phase Lock Loop) Synthesizer
<b>Frequency Accuracy</b>	: $\pm 135$ Hz
<b>Operating Temperature Range</b>	: $-20^{\circ}\text{C}$ to $+50^{\circ}\text{C}$
<b>Power Requirements</b>	: 13.8V DC (12-16 volts DC, negative or positive ground) or 120V AC (60 Hz)
<b>Antenna</b>	: 52 ohm (Coaxial connector)
<b>Microphone</b>	: 600 ohm Dynamic Type
<b>Speaker</b>	: 8 ohm, 2.5 Watt
<b>Size</b>	: 4"(H) x 13-1/2"(W) x 11-1/2"(D) (10 x 34 x 29 cm)
<b>Weight</b>	: 14 Lbs. (approx.) (6.5 kg)
<b>Accessories</b>	: DC Cord with in-line Fuse, Microphone and Microphone Hanger and Mounting Brackets

**RECEIVER:**

Max Sensitivity	: AM, 0.5 $\mu$ V SSB, 0.25 $\mu$ V
Sensitivity for 10 dB S/N	: AM, 0.5 $\mu$ V or better SSB, 0.25 $\mu$ V or better
AGC Figure of Merit 100 mV for 10 dB Change in Audio Output	: 90 dB
Overload AGC Characteristics from 100 mV to 1000 mV	: $\pm$ 3 dB
Overall Audio Fidelity at 6 dB Down	: 300 – 2100 Hz
Adjacent Channel Selectivity	: 70 dB
Image Rejection (42.6 MHz)	: 90 dB
IF Rejection	: 85 dB
Maximum Audio Output Power	: 4 Watts
Squelch Range	: Adjustable to 1 mV
Receiver Clarifier Range	: $\pm$ 1.25 kHz, variable
Battery Drain at no Signal	: 500 mA
Battery Drain at Max. Output Power	: 1,500 mA
AC Power Drain	: At no Signal – 40 Watts At Max. Output Power – 60 Watts

**TRANSMITTER:**

Max. Output Power	: AM, 4 Watts FCC SSB, 12 Watts FCC
Spurious Emission	: -65 dB or better
Modulation Frequency Response (1 kHz, 0 dB reference)	
Lower at 450 Hz, EIA	: AM, -6 dB
Upper at 2.5 kHz, EIA	: AM, -6 dB
Microphone Sensitivity	
AM : For 50% Mod.	: AM, 0.4 mV
SSB : For 4 Watts PEP	: SSB, 0.4 mV
Microphone Amplifier Circuit Dynamic Range	: AM, 60 dB (between 98% and 80% modulation) SSB, 60 dB (between 12W P.E.P. and 10W P.E.P.)
Battery Drain	: At no Modulation – AM/Less than 2,400 mA SSB/Less than 1,000 mA At Max. Output Power – AM/Less than 3,000 mA SSB/Less than 2,700 mA
AC Power Drain	: At no Modulation – AM/65 Watts SSB/45 Watts At Max. Output Power – AM/100 Watts SSB/100 Watts

**PUBLIC ADDRESS AMPLIFIER:**

Maximum Output Power	: 4 Watts
----------------------	-----------

**WARNING: To prevent fire or shock hazard, do not expose this Transceiver to rain or moisture.**

## F. C. C. LICENSE (U. S. A.)

Before transmitting with your Transceiver, you must have an FCC Citizens Band Radio Service License. If you don't have a license yet, you can fill out the Temporary Permit Form 555-B for a temporary license. Also, fill out and mail in FCC Form 505 CB License Application to:

**Federal Communications Commission  
P.O. Box 1010  
Gettysburg, Penn. 17326**

You must also read and know Part 95 of the FCC Plain English Rules; they apply to the operation of CB Radio Service unit. We've provided a copy of this regulation (along with the forms noted above).

**NOTE:** Units manufactured for sale in the U.S.A. can not legally be used in Canada. Canadian models have been D.O.C. approved and carry a D.O.C. approval label with its approval number.

## D. O. C. LICENSE (CANADA)

Before transmitting with your transceiver, you must obtain a Department of Communications (D.O.C.) General Radio Service License. We've provided such an application form with your unit – complete the form and mail with the appropriate fee to the Radio Regulations Office nearest you.

**DOC Approval Number:** \_\_\_\_\_

**NOTE:** Units manufactured for sale and use in Canada are not identical to units type-accepted by the FCC. Canadian models have been approved by D.O.C. and are to be used only in Canada.

### FREQUENCIES AVAILABLE FOR CB RADIO SERVICE

Channel	MHz	Channel	MHz
1	26.965	21	27.215
2	26.975	22	27.225
3	26.985	23	27.255
4	27.005	24	27.235
5	27.015	25	27.245
6	27.025	26	27.265
7	27.035	27	27.275
8	27.055	28	27.285
9	27.065	29	27.295
10	27.075	30	27.305
11	27.085	31	27.315
12	27.105	32	27.325
13	27.115	33	27.335
14	27.125	34	27.345
15	27.135	35	27.355
16	27.155	36	27.365
17	27.165	37	27.375
18	27.175	38	27.385
19	27.185	39	27.395
20	27.205	40	27.405

# INSTALLATION

**CAUTION:** Do not attempt to operate your Transceiver without an Antenna or dummy-load connected to the ANTENNA jack. To do so may damage your Transceiver.

For fixed or base station operation, simply connect the AC power plug of the Transceiver to a source of 120 volts 60 Hz AC power and set DC-AC switch on the back of the Transceiver to AC. The only other thing you require is an Antenna connection.

Safety and convenience are the primary considerations for mounting any piece of mobile equipment. All controls must be readily available to the operator without interfering with the movements necessary for safe operation of the vehicle. Be sure all cables are clear of the brake, clutch and accelerator. Also, thought must be given to the convenience of passengers (will they have adequate leg room?).

Another extremely important requirement is the ease of installation and removal (for service and maintenance). Mount the transceiver so it can be slipped in and out very easily.

The most common mounting position for a transceiver of this size is under the dashboard directly over the driveshaft hump. Do not mount the transceiver in the path of the heater or airconditioning air stream. Be sure the chassis of the transceiver is electrically connected to the ground system of the vehicle or boat. Use a separate ground wire to be sure.

When you have determined the best location for mounting, temporarily mount the brackets to the side of the unit. Use the unit, with brackets installed, as a template to mark where the holes are to be drilled. Take care when you drill holes that you do not drill into wiring, trim or other accessories. Remove the brackets from the unit and assemble them to the dash as shown in the illustration. Mount the Transceiver in position with bolts, lockwashers and nuts or self-threading screws.

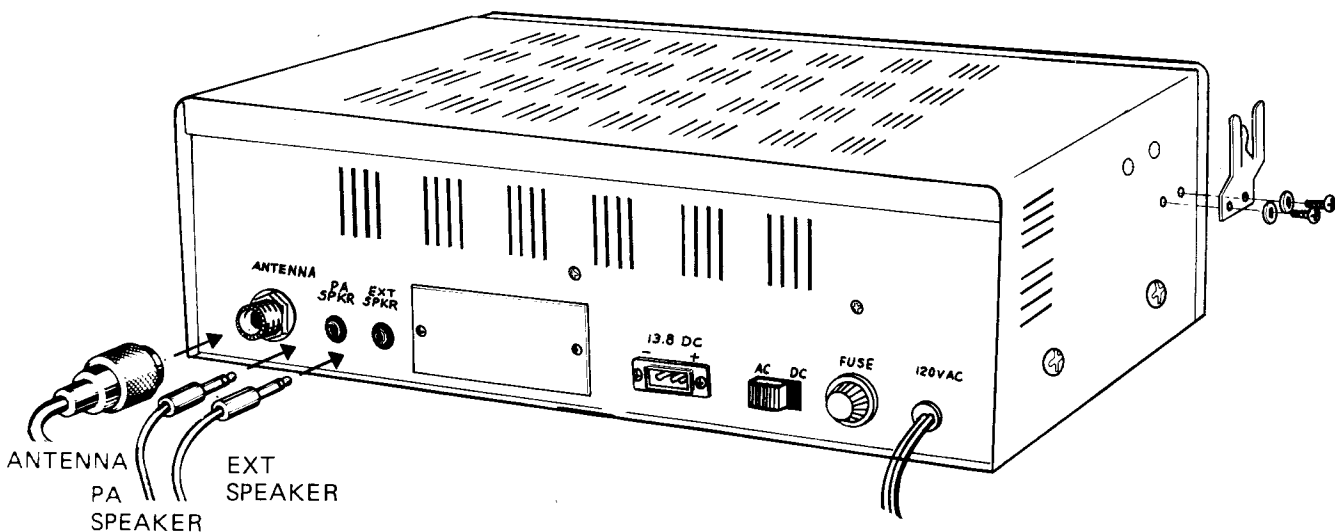

## FOR BASE INSTALLATION

## MOBILE INSTALLATION

**For Negative Ground Electrical Systems:** Connect the Black with stripe wire (with in-line fuse holder) to the Accessory terminal on the ignition switch of your vehicle. Make a good mechanical and electrical connection to the frame of the vehicle for the black (negative) wire. Set DC-AC switch to the DC position.

**For Positive Ground Electrical Systems:** Connect the Black wire to the Accessory switch "hot" terminal and connect the Black with stripe Wire to the metal frame of the vehicle. Thus, Black always goes to negative (-) and Black with stripe always goes to positive (+). Set DC-AC switch to the DC position.

You can use an auto accessory plug (Radio Shack Catalog No. 274-331) to connect your Transceiver to the vehicle's cigarette lighter socket. However, it is better to connect the DC power cord directly to the accessory terminal of the ignition switch. This will prevent unauthorized usage of the Transceiver, and will also prevent you from leaving the Transceiver on unintentionally.

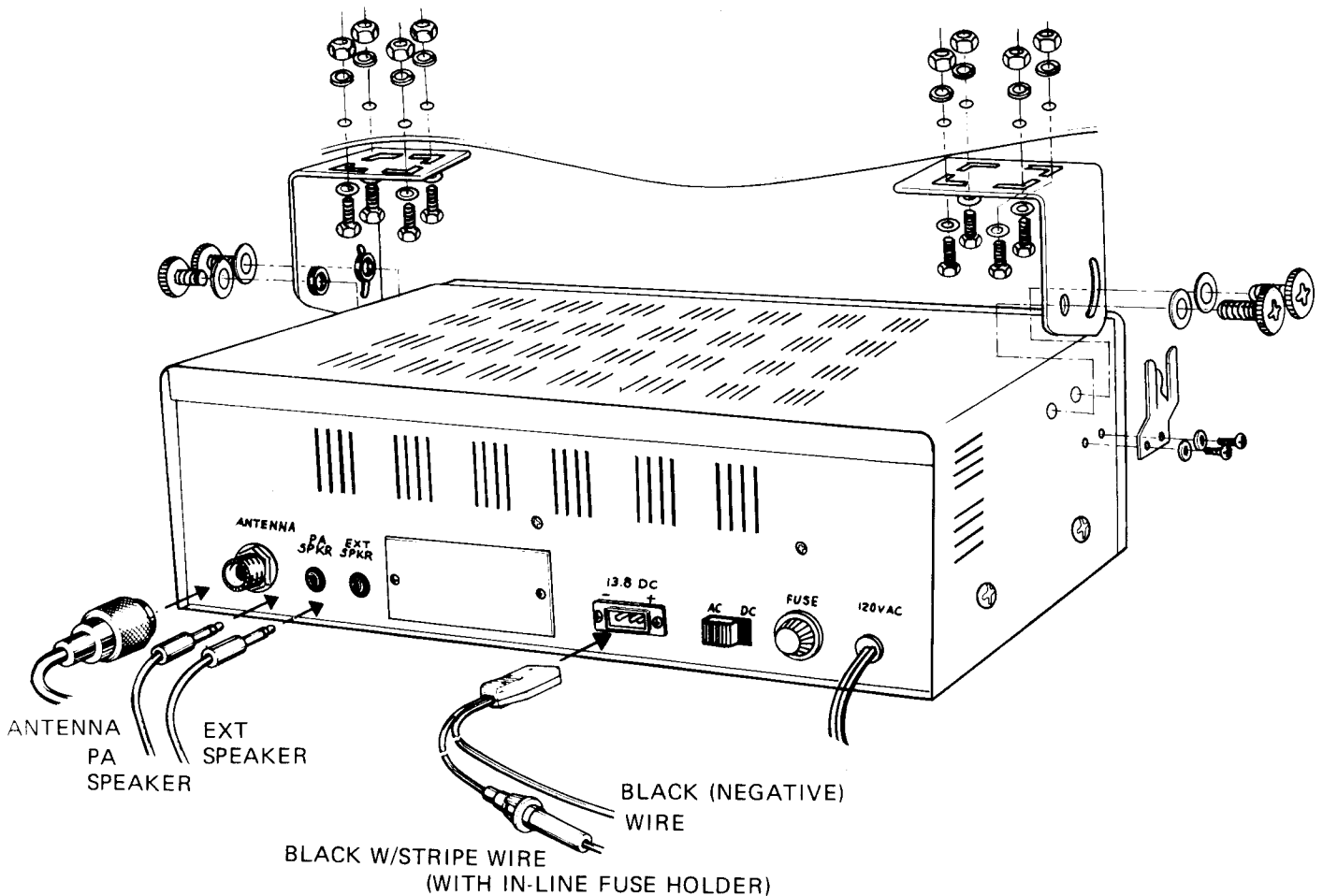

## FOR MOBILE INSTALLATION

# ANTENNA SYSTEM

The antenna system includes the transmission line, and it is very important that you use the correct type of transmission line. The transmission line should be of the coaxial type and should have an impedance equal to the antenna impedance.

Since your Transceiver is designed to operate most efficiently into a 50 ohm load, it is best to use a type of coaxial cable with an impedance of 50 ohms. We suggest type RG-58/U for short lengths and RG-8/U for long lengths.

Generally speaking, you should keep the length of the transmission line to a minimum. Remember that line losses increase with frequency. Use foam-insulation coax for best results.

The above discussion is as important for reception as it is for transmission. If a mismatch exists between the antenna and the receiver, the excellent sensitivity and signal-to-noise ratio of the receiver circuitry will be defeated.

## FIXED STATION ANTENNAS

The most popular fixed station antenna is a complex colinear or ground plane.

Beam antennas provide maximum gain and maximum directivity. The directivity can be a disadvantage unless a rotor is used. Since a beam antenna is directional, it greatly reduces noise and interference from all other directions. This can be a decided advantage on the CB bands where man-made noise is a problem.

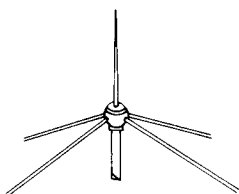

GROUND PLANE

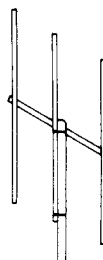

VERTICAL BEAM

## BASE STATION ANTENNAS

Your Radio Shack store carries a complete line of base station CB antennas and accessories. For maximum efficiency, we strongly recommend using an SWR meter to aid in the proper matching between your antenna and Transceiver.

The antenna system should be adequately grounded.

Always use a lightning arrester for your antenna system.

## MOBILE STATION ANTENNAS

Mobile CB antennas are one of two types, a full-length or a loaded whip. Your Radio Shack store carries a complete line of both types of mobile antennas.

The location of the antenna has a great effect on the antenna efficiency and directivity. Antennas mounted in the center of the roof radiate equally in all directions. A bumper-mounted antenna radiates in a pattern directly in front of and to the rear of the vehicle, with maximum radiation directly away from the vehicle, in a horizontal plane.

Since the normal  $\frac{1}{4}$  wavelength whip antenna is too long (102" [2.6m] ) for roof mounting on a vehicle, the antenna is shortened and a loading coil is utilized to provide the proper electrical length. As a result, the overall efficiency is reduced and the nondirectional advantage is defeated. Thus, a bumper-mounted full-length whip antenna will normally give the best results.

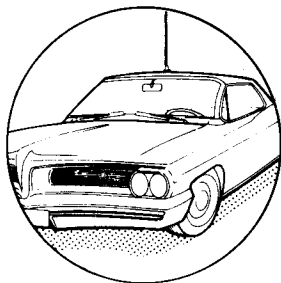

ROOF MOUNT

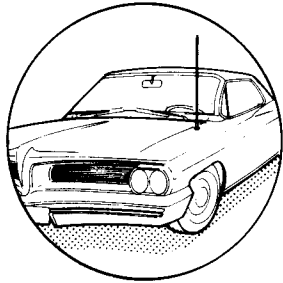

FRONT COWL MOUNT

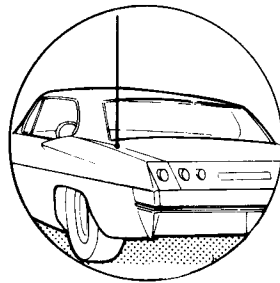

REAR DECK MOUNT

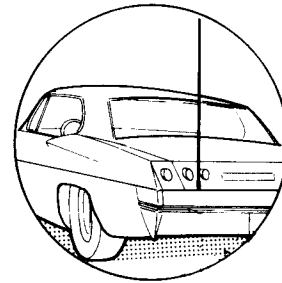

BUMPER MOUNT

A few general rules should be followed for proper installation of any mobile antenna:

1. Keep it as far as possible from the main bulk of the vehicle.
2. Keep as much of it as possible above the highest point of the vehicle or boat.
3. During operation, it must be vertical. Thus, it should be mechanically rigid so it will maintain a vertical position when the vehicle or boat is in motion.
4. Mount it as far as possible from sources of noise (ignition system, gauges, etc.) and convenient for transmission line routing away from these noise sources.

An antenna mounted in a boat requires a ground. This can be either the metal hull or a ground made of tin-foil or copper sheeting. This ground should cover an area of 12 square feet (1 m<sup>2</sup>) or more. Be sure the transceiver has an adequate ground as well. If you use Radio Shack's 102" (2.6 m) Fiberglass Marine Antenna (21-912), you won't need a ground; it has been designed with its own "ground" system.

## NOISE

Your vehicle or boat can be the cause of much noise interference. Your TRC-490 incorporates a switchable Automatic Noise Limiter circuit for AM and a Noise Blanker for both AM and SSB reception. Also, it has built-in power supply filtering. These circuits can help to reduce and/or eliminate annoying noise.

Remember, your Transceiver has a very sensitive receiver and it will pick up even the smallest trace of ignition noise. Any noise that you hear in the Transceiver is almost totally from external sources. The receiver itself is exceptionally quiet. Steady high noise levels can not be eliminated by the internal Automatic Noise Limiter and Noise Blanker circuits. Noise problems can not be solved internally (in the Transceiver); they must be solved at the source of the noise.

If you wonder if the noise is from your ignition system, the Transceiver or an external source, try this simple test: Turn your ignition switch off and set it to ACC (accessories). This turns off the ignition, but supplies power to the Transceiver. Most of the noise will disappear—indicating that the source of noise is your ignition system.

This interfering noise can be generated anywhere in the electrical system of the vehicle or boat. The first step in reducing or eliminating this noise is to locate the source of the noise.



## IGNITION SYSTEM

The most common source of noise is the ignition system. This noise can be identified by the fact that, it varies with the speed of the engine. It consists of a series of popping sounds occurring at a regular rate that will vary with the speed of the engine and stop when the ignition is turned off.

There are a number of things that can be done to reduce this type of noise:

1. Use only the "radio suppression type" high voltage ignition wire. Most new cars come already equipped with this type of wire.
2. Inspect the high voltage ignition wire and all connections made with this wire. Old ignition wire may develop leakage, resulting in hash.
3. If noise still persists, replace the spark plugs with spark plugs that have suppressor resistors built-in. Be sure to use the correct type for your vehicle.

Other sources of noise are: generator/alternator, regulator, gauges and static discharge. Most of these types of noise can be effectively reduced or eliminated by using bypass capacitors at the various output voltage points. Once again, we suggest you check your Radio Shack store for a selection of noise reduction accessories.

# CONTROLS AND THEIR FUNCTIONS

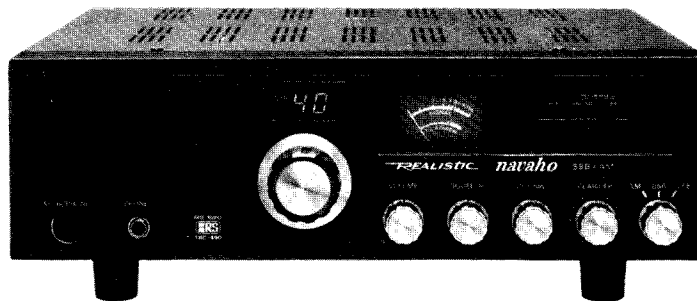
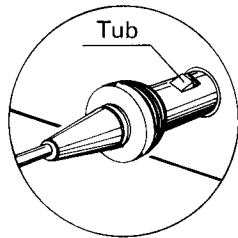

This short description of the function of each control and jack supplies background information for proper operation. For actual Operating Instructions, refer to **Using Your Transceiver**.

**MICROPHONE** . . . The dynamic microphone must be connected to this jack. To Transmit, press the button on the mic and talk into the mic. To Receive, release the button. When transmitting, hold the microphone at an angle, two or three inches (5–7.5 cm) from your mouth and speak clearly in a normal voice. Your Transceiver features a new locking type microphone connector. This insures that you won't accidentally pull out or loosen the plug connection (when extending the MIC cable while moving about). To release the MIC connector, you must press the small Tab (see illustration above) on the Top and then pull out.

**PHONES** . . . Plug in communications type headphones for private listening, or in areas where background noise is excessive (factories, at the scene of an accident or fire, etc.). When you plug in the headphones, it automatically disconnects the internal speaker (or an external speaker).

**Channel Selector** . . . use to select any one of the standard 40 CB channels.

**VOLUME with "ON/OFF" switch** . . . Turn clockwise to apply power to the unit and then adjust for the desired level of sound from the speaker. When using PA, it controls the level of the PA output.

**SQUELCH** . . . Sets the level of the internal Squelch circuitry to cut out the background noise when no signal is being received. When properly set, it allows signals to come through, but cuts off the receiver sound when no signal is being received, thus eliminating annoying background/atmospheric noise during standby and monitoring conditions.

If set too high, you may miss some of the weaker signals. Operating conditions will determine the best setting.

**RF GAIN** . . . Varies the sensitivity of the RF amplifier stages of the Receiver circuitry. For normal operation, set RF GAIN to maximum and adjust VOLUME for a suitable listening level. Under high-signal conditions, you may want to turn RF GAIN down a little and raise VOLUME as required.

**CLARIFIER** . . . Functions as a "fine tuning" (or "delta" tuning) for reception of Single Sideband and AM signals when the Mode switch is set to either LSB or USB. This permits you to tune your receiver to exactly the same frequency of any other station or stations which you are communicating with.

**AM-USB-LSB Mode Switch** . . . set this switch to the desired mode of operation for both transmit and receive. When in the AM position, both transmitter and receiver sections are operative for AM. When set to the LSB position, the Receiver operates to receive only the lower sideband portion of a signal; the Transmitter will transmit only the lower sideband of the modulated waveform. In the USB position, the Receiver operates only to receive the upper sideband portion of a signal; the Transmitter will transmit only the upper sideband of the modulated waveform.

**PA push-button** . . . Controls the function of the audio amplifier/modulation circuitry when the Microphone button is pressed. When the PA button is in the "out" position, the Microphone button turns the Transmitter on for normal transmissions. When you press the button in, the Transmitter will not function—the Microphone turns on the Public Address Amplifier function. For PA operation you must have a PA speaker connected to the PA jack on the rear chassis.

**ANL/NB push button** . . . press in to cut out annoying hash-type and impulse-type noises. Press again to release this function. NB(Noise Blanker) is particularly effective for ignition noise on both AM and SSB, while ANL(Automatic Noise Limiter) is effective for AM signals.

**RF-S Meter** . . . gives visual indication of signal strengths. When receiving, the RF-S Meter shows the strength of incoming signals; a change of one "S" unit indicates a change of 6 dB in signal strength. The meter is set up so that a 100 microvolt signal will produce a reading of S-9. When Transmitting, the RF-S meter gives a relative indication of output power from the Transmitter.

**PA + CB RECEIVE push button** . . . press in both ANL/NB and PA to activate PA operation plus CB RECEIVE function; you can monitor the CB signal from your PA speaker when the microphone button is released.

**CH9 Switch** . . . Press in and you instantly jump to channel 9. Press again to release this function and Transceiver will return to the previously selected channel.

**Channel 9 Indicator LED** . . . Lights up when you are using the "instant" Channel 9 function.

## THE REAR PANEL

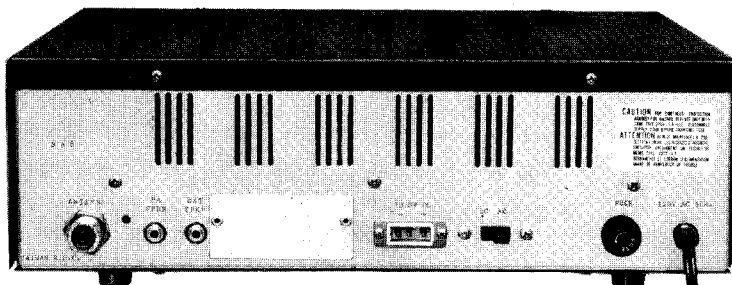

**PA SPeaKeR Jack** . . . connect an 8-ohm Public Address speaker to this jack for PA use. We recommend Radio Shack's 40-1244, weatherized, rugged PA Speaker, as an ideal unit for either PA or External Speaker application.

**EXTeRnal SPeaKeR Jack** . . . if you want to use an external speaker, plug it into this jack. You should use a standard 8 ohm type. When a miniature (9/64", 3.5 mm) phone plug is inserted into this jack, the built-in speaker is automatically disconnected.

**ANTENNA Coax Connector** . . . connect your CB antenna to this (SO-239 type, accepts PL-259 connectors).

**FUSE** . . . is for protection of the Transceiver and its source of AC power. If the Transceiver does not operate from AC power, check this fuse—replace only with the same type and value (4 amp).

**13.8V DC Connector and Power Cable with in-line fuse** . . . this cable is to be connected to a source of 12–16 volts DC power, negative or positive ground. The Red wire with the in-line fuse must be connected to the + side and the Black wire to the – side.

**120V AC POWER CORD** . . . plug into a source of 120 volts, 60 Hz AC power.

**DC-AC Switch** . . . selects the power source, DC or AC.

# USING YOUR TRANSCEIVER

**Note:** For detailed information on Installing, refer to INSTALLATION. Do not transmit without an Antenna or suitable load connected. Do not operate the PA function without a speaker connected to the PA SPKR jack.

Your Transceiver can be used either as a base or mobile unit.

For base operation, connect the AC power plug to a source of 120 volts, 60 Hz AC power. Set the DC-AC switch on the back of Transceiver to AC position. Connect coaxial transmission cable from your antenna to the ANTENNA coax connector on the rear panel.

For most efficient operation and safety, use a separate ground wire connection between the chassis of your Transceiver and a cold water pipe or ground rod.

For mobile operation, use the 12-volt DC power cable and set DC-AC switch to the DC position. Also connect Antenna and ground and make all necessary mounting requirements.

## TO RECEIVE AM SIGNALS

1. Set **RF GAIN** control maximum clockwise.
2. Set **SQUELCH** control maximum counterclockwise.
3. Set Mode to **AM**.
4. Turn power "on" by rotating **VOLUME** clockwise.
5. Set **Channel Selector** to the desired channel.
6. Adjust **SQUELCH** to cut out annoying background noise when no signal is being received. To do this, set **Channel Selector** to a channel where no signals are present (or wait till signals cease on your channel). Then, rotate **SQUELCH** in a clockwise direction to the point where the background noise just stops. Now, when a signal is present, you will hear it, but will not be disturbed by noise on the channel in between signals.

When properly set, **SQUELCH** will keep the receiver "dead" until a signal comes in on that channel. Do not set **SQUELCH** too high, or weak signals will not be able to "open" the Squelch circuit. To receive weak signals, it is best to leave **SQUELCH** set to the minimum position (maximum counterclockwise).

7. Use **CLARIFIER** to tune in slightly off-frequency stations, or to tune out adjacent channel interference caused by a station on the next channel (which may be too close to your channel).
8. Adjust **VOLUME** for a suitable listening level.
9. Push **ANL/NB** button in if your reception is disturbed by interference from impulse-type noise (ignition noise and other man-made electrical noise) or hash-type noise (fluorescent light and other types of constant broad-frequency type noise).
10. Use **CH 9** switch to instantly check Channel 9 activity.

For most distinct reception, plug communications-type headphones (such as Radio Shack Catalog Number 279-200) into **PHONES** jack. This will be particularly helpful when operating in high noise surroundings (factory, construction site, etc.)

Often you'll find an external/remote speaker will be most advantageous. We've made provisions for connecting such a speaker—just connect it to the **EXT SPKR** jack on the back. Radio Shack sells a number of fine speakers for this purpose—we recommend Catalog Number **21-549**. When you connect a speaker to this jack it automatically disconnects the internal speaker.



**21 – 549**

### **TO RECEIVE SSB OR DSB SIGNALS**

1. Set **RF GAIN** maximum clockwise.
2. Set **SQUELCH** maximum counterclockwise.
3. Set Mode to either **LSB** (lower sideband) or **USB** (upper sideband), depending on which sideband is being used by the transmitting station.

**NOTE:** When receiving DSB (double sideband) signals, you can use either **LSB** or **USB**.

4. Turn power "on" by rotating **VOLUME** clockwise.
5. Set **Channel Selector** to the desired channel.
6. Adjust **SQUELCH** as noted above.
7. Use **CLARIFIER** to tune in the SSB signal.

SSB tuning takes practice; it is not difficult, it just takes a little experience. When first listening to an SSB signal, it probably will not be understandable; the voice may sound like "Donald Duck", or just a low guttural sound. In either case, very slowly adjust **CLARIFIER** to bring the signal into its natural voice tonal range.

If the signal is Donald Duck type, tune so the signal tones become lower in tone; careful tuning will make the voice sound natural. If the signal is low and guttural, tune for higher tones.

**NOTE:** If you try the above procedure and are not able to make the signal intelligible, it may be an SSB signal operating on the other sideband—try the other SSB Mode (**LSB** or **USB** as the case may be).

8. Adjust **VOLUME** for a suitable listening level.

Use **ANL/NB** to reduce or eliminate noise interference.

### **Notes on Receiving**

An SSB signal will produce a fluttering, unintelligible sound when receiving in the **AM** mode; in such a case, use either the **LSB** or **USB** mode and adjust **CLARIFIER** for intelligibility.

You can tune AM signals when the Mode switch is in the **USB** or **LSB** position; tune **CLARIFIER** control to eliminate the steady tone caused by the AM carrier ("zero-beat" the tone so it disappears).

Remember that adjustment of **CLARIFIER** only shifts the Receiving frequency, **not** the Transmitting frequency.

When receiving an extremely strong SSB signal, you will find it best to use the **RF GAIN** control to vary the volume (rather than using **VOLUME**).

## TRANSMITTER OPERATION

1. Be sure PA button is out.
2. Plug the Microphone into the **MIC**rophone jack.
3. Set Mode Switch to the desired position.
4. Select the desired channel of operation.
5. Press the push-to-talk button on the side of the Microphone and speak in a normal voice into the Microphone. Best results will be obtained when you hold the mic 1 to 4" (2.5-10 cm) from your mouth and turned at about a 45° angle (not straight on).
6. When transmitting, the meters will turn red. The RF-S Meter will indicate the relative level of output power.
7. To receive, release the push-to-talk button.



## USING THE PUBLIC ADDRESS AMPLIFIER FEATURE

You can use your Transceiver to provide 4-6 watts of audio power as a Public Address amplifier. To use this function, you must connect an 8 ohm public address type speaker to the **PA SPeaKeR** jack on the rear of this unit. We recommend Radio Shack's 40-1244; it's a weatherized 4" (10 cm) speaker, specifically made for PA use.



40-1244

1. Be sure an 8 ohm speaker is connected to the **PA SPeaKeR** jack.
2. Push in PA button.
3. Turn the Transceiver "on" with the **VOLUME** control.
4. Connect the microphone and press the push-to-talk button and talk into the mic. Adjust **VOLUME** as required for the appropriate level of sound.
5. Even though you have your Transceiver set for PA operation, you can still monitor **CB** signals—press in both **PA** and **ANL/NB** buttons, and **CB** signals will be heard through the **PA** speaker. This way you won't miss any important calls, even while using **PA**.  
To defeat the receiver sound, press **ANL/NB** button again to release it.
6. To return to normal Transceiver operation, press **PA** button to release it.

# SSB (SINGLE SIDEBAND) . . . WHAT IS IT?

We thought you'd be interested in knowing and understanding something about the SSB function and capability of your Transceiver.

To understand SSB, we need to know what an AM (Amplitude Modulated) signal is.

Amplitude Modulation is a form of heterodyning—mixing 2 signals together electrically. In the process of mixing, 3 signals result. Example:

An R.F. signal at 27.005 MHz (channel 4 C.B.) is mixed with (modulated by) a 1000 Hz tone.

The resulting signals —

27.005 MHz = original or "carrier" signal

27.005 MHz - 1000 Hz (27,005,000 minus 1000) = 27.004 MHz, the Lower Sideband

27.005 MHz + 1000 Hz (27,005,000 plus 1000) = 27.006 MHz, the Upper Sideband

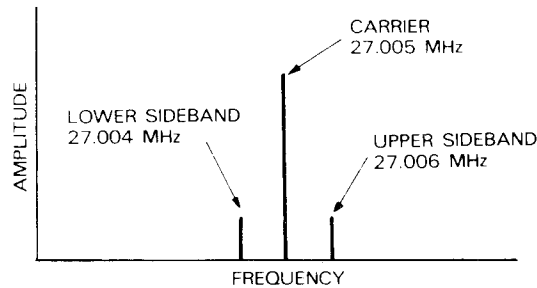

Notice that the communication or intelligence (the 1000 Hz tone) is contained in **each** sideband. The Carrier contains no intelligence. This fact is vital!

For the sake of communication, all we need to receive is the 1000 Hz tone. The receiver only needs to recover one signal, and yet we are transmitting 3 signals. Not only are we sending 3 signals, but also we are wasting most of our power in one of them (which carries none of the intelligence, i.e. the carrier, 27.005 MHz) **and the other two signals duplicate each other!**

Thus, if we can eliminate the carrier (not needed for communication) and can send only one of the sidebands (since they duplicate each other's information anyway), we could concentrate all of the transmitting power into one sideband. This is exactly what Single Sideband accomplishes.

Single Sideband transmissions incorporate **only** one of the sidebands—i.e. in the example above, **only** the upper sideband at 27.006 MHz or **only** the lower sideband at 27.004 MHz. The second sideband and the carrier are eliminated in the early stages of the transmitter circuitry.

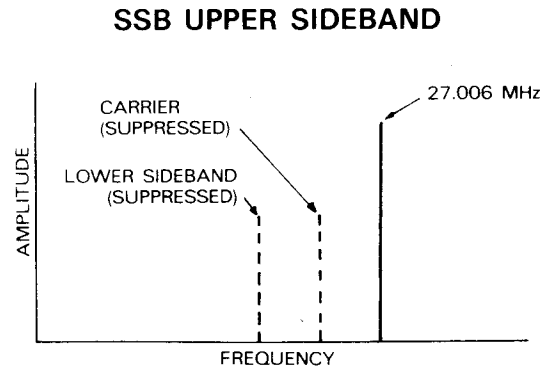
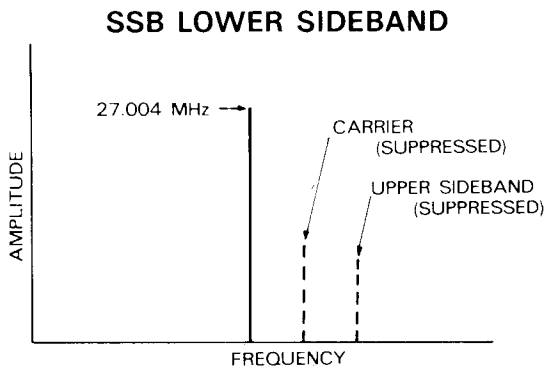

When only one sideband is transmitted, we can concentrate all of the available power in this one sideband, greatly increasing the effective power of an SSB signal as compared to an AM signal.

See Advantages of SSB Over Normal AM.

## ADVANTAGES OF SSB OVER NORMAL AM

A theoretically perfect AM transmitter used in the Citizens Band Radio Service as permitted by the Federal Communications Commission will have the following maximum output power specification:

Carrier --- 4 watts with the capability of slightly less than 100% modulation

In order to fully Amplitude Modulate a 4 watt carrier, a full 2 watts of audio power is required. In this case, only 1 watt of power can exist in each sideband. Since the carrier contains no intelligence, and the sidebands duplicate each other, really only one sideband is required to transmit the required intelligence.

If we take the above transmitter and convert it to Double Sideband operation (eliminate the carrier power), we can increase the power in the sidebands to 2 watts each, without overloading the circuitry. Further, if we eliminate one of the two sidebands, we can put the full 4 watts of power into the remaining sideband. Thus, while an AM transmitter has only 1 watt of power in one sideband, an SSB transmitter can have 4 watts of power in one sideband—or **4 times the power of an AM transmitter.**

Thus, effectively an SSB transmitter with the same power limitations is 4 times more powerful than an AM transmitter.

One further advantage, which is not often mentioned. Not only does the SSB signal take up only 1/2 of the frequency spectrum space of an AM signal (only 1 sideband instead of 2), thus permitting twice the number of stations to be in the same amount of band space—but also, at the receiving end, the receiver only picks up 1/2 of the total AM bandwidth. This means that 50% less noise is amplified along with the signal. This results in a 50% improvement in signal-to-noise figures; or, in more technical terms, a 3 dB improvement.

Thus, given equal limitations and conditions, an SSB signal will be 4 times more powerful and will have 2 times the signal-to-noise advantage of an AM signal—**8 times as effective.** in technical terms, a 9 dB advantage. Thus, for an AM transmitter to be equivalent in effectiveness it would have to be rated at 32 watts!

Enough said! We hope you're enthused.



# MAINTENANCE

Since only the finest quality parts are used throughout your Transceiver (and these are all conservatively rated), you will need little or no service or repair of the unit.

Be sure you treat it with the care deserving of such a piece of electronic equipment. It is rugged and designed for either base or mobile use—but do not abuse it. Be sure you always make proper connections and adequate mounting provisions.

**If you run into problems with the unit, we recommend you check the following:**

1. If trouble is experienced with receiving.
  - Check the **VOLUME** On/Off switch setting.
  - Be sure **SQUELCH** is adjusted properly. Is it over-squelched?
  - Check if the unit is switched to an operating channel.
2. If trouble is experienced with transmitting.
  - Check if the transmission line is securely connected to the ANTENNA Connector.
  - Check to be sure the antenna is OK.
  - Are all transmission line connections secure and free of corrosion?
  - Make sure you are fully pressing the Push-To-Talk Button on the Mic.
  - Be sure Mic connector is firmly pressed into its jack.
3. If the Transceiver is completely inoperative.
  - Check the power cable and in line fuse (4A).
  - Be sure DC-AC switch is in correct position.

If these checks don't solve the trouble, do **NOT** attempt repairs or adjustments yourself. The unit should be serviced only by a qualified radio technician. Whenever possible, return the unit to the store from which it was purchased.

## WARNING

Do not open up the Transceiver to make any internal adjustments. Any internal adjustments can be made only by (or under the direct supervision of) a person holding a Federal Communications Commission Radio Telephone 1st or 2nd Class License.

Internal adjustments and/or modifications can lead to illegal operation as defined by FCC Rules and Regulations, Part 95. Such illegal operation can lead to very serious consequences.

# SCHEMATIC DIAGRAM

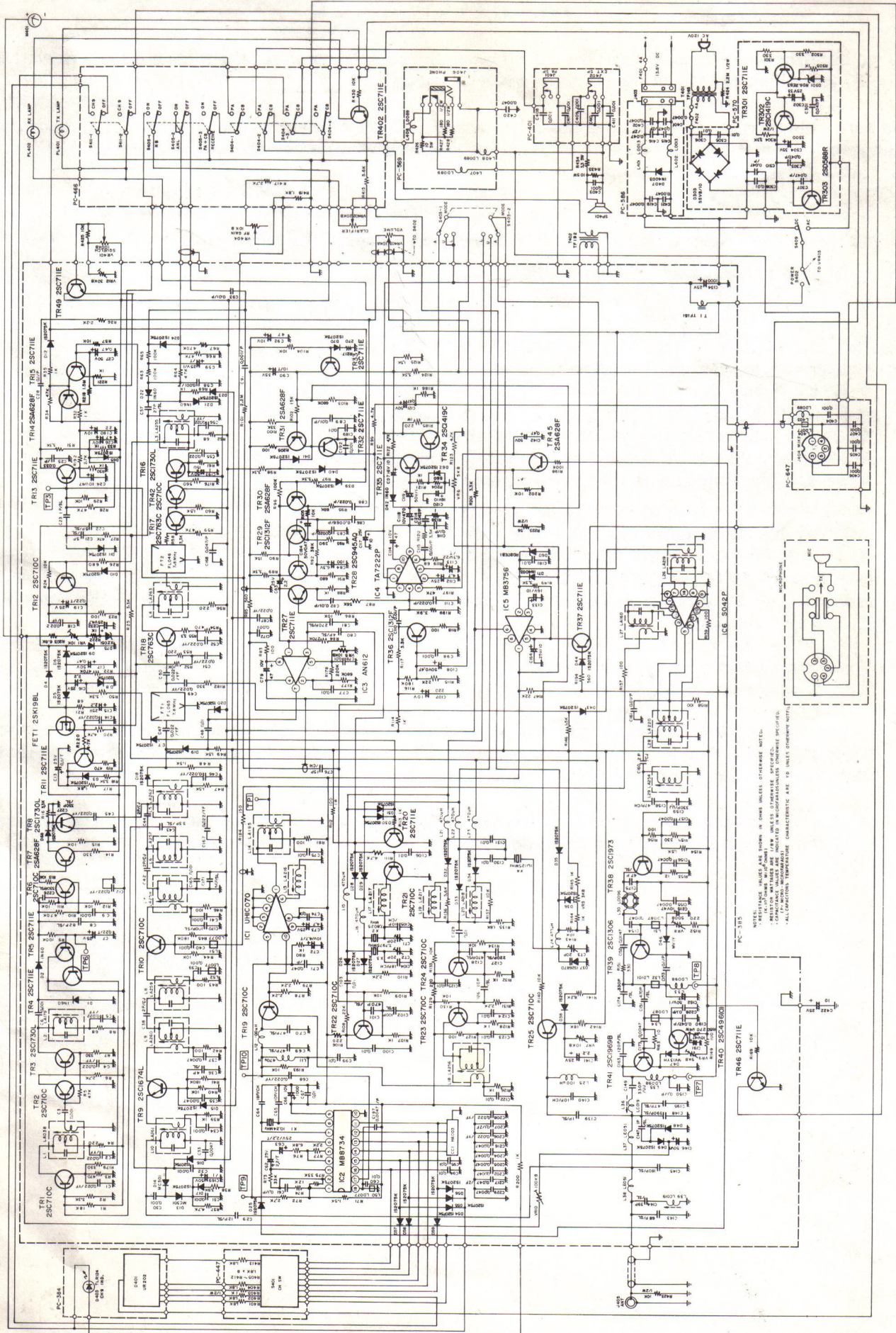

RESISTANCE VALUES ARE SHOWN IN OHMS UNLESS OTHERWISE NOTED.  
RESISTOR VALUES ARE IN KΩ UNLESS OTHERWISE SPECIFIED.  
CAPACITANCE VALUES ARE IN MICROFARADS UNLESS OTHERWISE SPECIFIED.  
ALL COMPONENT TEMPERATURE CHARACTERISTICS ARE TO UNLESS OTHERWISE NOTED.

CHANGE CHIP MB8734 TO MB8719

PROGRAMMABLE DIVIDER PINS - 7-16

CUT PIN 12 SHUNT WITH A 2.7K 1/4WATT RESISTOR

CUT PIN 10 IF GROUNDING SHUNT WITH A 2.7K 1/4WATT RESISTOR

ADJUST L18

M: RePlay / 2 3 4 5

### RADIO SHACK LIMITED WARRANTY

This equipment is warranted against defects for 90 days from date of purchase. Within this period, we will repair it without charge for parts and labor. Simply **bring your sales slip** as proof of purchase date to any Radio Shack store. Warranty does not cover transportation costs. Nor does it cover equipment subjected to misuse or accidental damage.

This Warranty gives you specific legal rights and you may also have other rights which vary from state to state.

*We Service What We Sell*

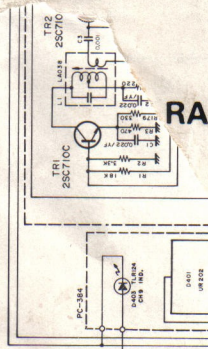

**RADIO SHACK**  **A DIVISION OF TANDY CORPORATION**

**U.S.A.: FORT WORTH, TEXAS 76102**

**CANADA: BARRIE, ONTARIO L4M 4W5**

**TANDY CORPORATION**

**BELGIUM**

**U. K.**

**ORIA ROAD  
S.W. 2116**

**PARC INDUSTRIEL DE NANINNE  
5140 NANINNE**

**BILSTON ROAD, WEDNESBURY  
WEST MIDLANDS WS10 7JN**

Printed in Taiwan