

SAME FUNCTION BUT DIFFERENT PINOUT AS SN7400.

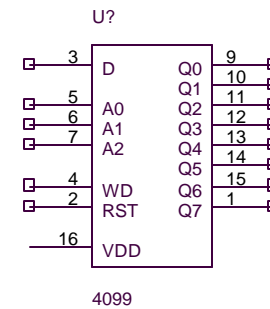
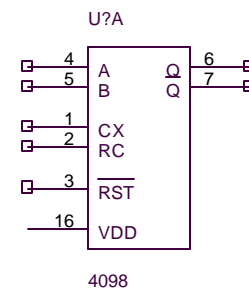
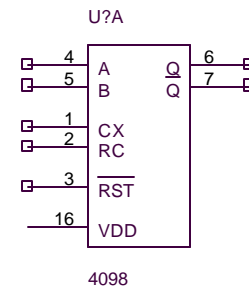
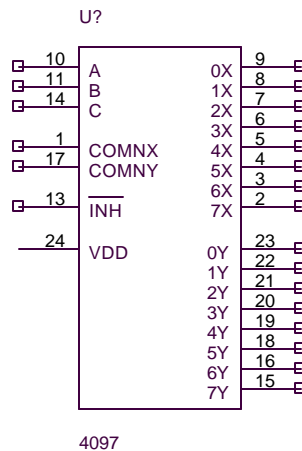
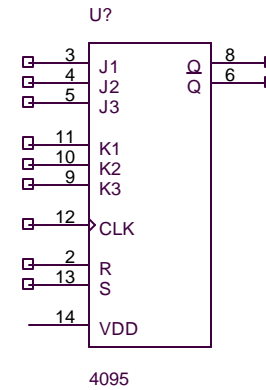
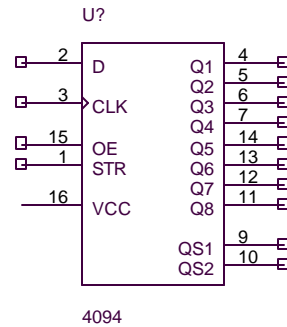
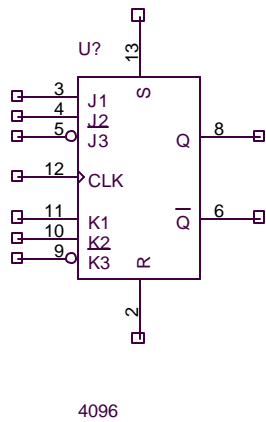

Title		
4xxx SERIES CMOS DEVICES		
Size	Document Number	Rev
A	0106061810	1
Date:	Sunday, June 18, 2006	Sheet 1 of 1