



**Engineer's Quick Ref. Guide**  
**722773004 G4**

---

**CashFlow® 690 Series Changeover Field  
Service Engineer's Quick Reference Guide**

Part No. 722773004

Version: G4

Publication date: May 2006

Published by:

MEI



Internet: <http://www.meigroup.com>

**©, MEI UK International Ltd., 2006**

Except as permitted under the relevant local legislation, no part of this publication may be copied, transmitted, transcribed, or distributed in any form or by any means, or stored in a database retrieval system, or translated into any language (natural or computer), without the prior permission of MEI.

MEI reserves the right to change the product or the product specifications at any time. While every effort has been made to ensure that the information in this publication is accurate, MEI disclaim any liability for any direct or indirect losses (howsoever caused) arising out of use or reliance on the information included in this Quick Reference Guide.

This document does not necessarily imply product availability.

For information about the availability of translated versions of this Quick Reference Guide, please write to the Technical Service Manager at the above address.

CashFlow® and the MEI device are registered trademarks.  
Copyright MEI 2006.

# Contents

**Contents.....3**

**Safety .....7**

National and International Standards Conformance.....7

Rated Operating Voltage .....7

Dangerous Environments .....7

Product Disposal .....7

**Fault Finding.....9**

Current Status .....9

Amber Light .....10

Amber LED Steady.....11

Amber Flash x 1 .....11

Amber Flashes x 2.....13

Amber Flashes x 3.....14

Amber Flashes x 4.....15

No LED On .....15

**Fuse Replacement .....17**

**Changeover Replacement .....19**

Before You Begin .....19

Removing .....19

Installing .....19

    Installation Checks .....20

    Connecting.....20

---

<b>Module Replacement .....</b>	<b>21</b>
Coin Tube Cassette.....	21
Removing.....	21
Installing .....	21
Acceptor/Separator.....	22
Removing.....	22
Installing .....	23
Keypad Assembly.....	23
Removing.....	23
Installing .....	24
Transformer .....	24
Removing.....	24
Installing .....	25
Dispenser .....	26
Removing.....	26
Installing .....	27
<b>Service Procedures.....</b>	<b>29</b>
Float .....	29
Float Up.....	29
Float Down.....	29
Float Teach.....	29
Float Reset .....	29
Configure.....	30
Enable or Inhibit a Coin.....	30
Show Channel Details.....	30
Select a Euro Transition Stage (1 to 4).....	30
Price Teach .....	30
Cassette Set .....	31

Engineer's Quick Reference	Contents
Group 1 Cassette.....	31
Group 2 Cassette.....	31
Customise a Cassette.....	31
Audit.....	31
Manually Filled Coin Tube.....	32
Empty the Coin Tubes.....	32
<b>Setup Procedures .....</b>	<b>33</b>
Procedural Overview.....	33
Setup Configuration Options.....	33
Functions and Variants.....	33
Configuration Options.....	36
<b>Product support .....</b>	<b>41</b>

*This page is intentionally blank*

## Safety

### National and International Standards Conformance

CashFlow 690 Series products operate at Safety Extra Low Voltage Level (SELV) as defined in IEC335/EN60335 '*Safety of Household and Similar Appliances*'. They may be designed into equipment complying with IEC335/EN60335 or IEC950/EN60950 '*Safety of Information Technology Equipment*'.

CashFlow 690 Series products are of Class 2 construction.

### Rated Operating Voltage

The operating voltage of a CashFlow 690 Series Change giver is stated on the product. The Change giver must be used with any power source other than that indicated.

### Dangerous Environments

The CashFlow 690 Series Change giver must not be operated in the presence of flammable gasses, fumes or water.

### Product Disposal

Do not dispose of any part of a CashFlow 690 Series Change giver by incineration.

*This page is intentionally blank*



## Fault Finding

### Current Status

The current status of the Change giver is indicated by the colour of the LED on the keypad.

- ❑ **Red/Amber/Green (alternating)** – occurs briefly when the Change giver is first switched on
- ❑ **Green** - the Change giver is working correctly
- ❑ **Green (flashing)** – occurs when the keypad is in either the Service or Setup mode
- ❑ **Amber** –there is a fault with the vending machine
- ❑ **Amber (flashing)** – the Change giver has a fault that can be rectified, possibly on site
- ❑ **Red** – there is a fault with the change giver acceptor module
- ❑ **Red/Green (alternating)** – there is a serious hardware or software fault and that the Change giver must be replaced
- ❑ **No LED on** – possible power supply problem

### Amber Light

The amber light may be steady or flash in a sequence of from one to four flashes. At the same time, an error message is displayed on the LCD display "A".

The number of flashes identifies the problem module as indicated below.

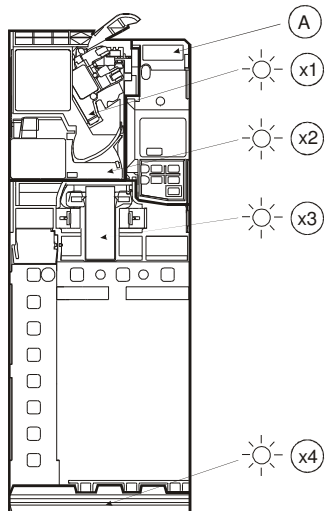

1	Discriminator	2	Acceptor
3	Separator	4	Dispenser
A	LCD Display		

**Amber LED Steady**

**Displayed message:** *"Inhibited by VMC"*

**Problem:** vending machine not communicating with the Change giver

**Effect:** no coins accepted

**Possible causes:**

- 1 Faulty connection to the vending machine
- 2 No merchandise available
- 3 Jammed or faulty merchandise dispenser
- 4 Vending machine controller problem

**Action to take:**

- 1 Check the loom connecting the Change giver to the vending machine is secure
- 2 Reset the power
- 3 If appropriate, replenish the vending machine

**Amber Flash x 1**

Four messages can appear as follows:

**Displayed message:** *"Coin Jam"*

**Faulty module:** discriminator

**Effect:** no coins are accepted

**Possible cause:** coin jam

**Action to take:**

- 1 Check for a coin jam
- 2 Check that the reject lever mechanism is functioning freely
- 3 Check there is clearance between the Change giver and vending machine escrow levers

**Displayed message:** *"Clean-Me"***Faulty module:** discriminator**Effect:** coin acceptance decreased to below an acceptable level**Possible cause:** dirty coin paths**Action to take:** clean the coin paths. On the keypad, press **Mode A** **Mode** to stop the LED flashing**Displayed message:** *"Escrow pressed"***Faulty module:** discriminator**Effect:** No coins accepted**Possible cause:** Escrow jammed open; reject lever stuck**Action to take:**

- 1 Check flight deck
- 2 Check Change giver escrow lever is functioning freely
- 3 Check escrow mechanics of the vending machine are functioning freely
- 4 Check there is clearance between the escrow lever on the Change giver and the lever on the vending machine

**Displayed message:** *"Coin Sensor Error"*

**Faulty module:** discriminator

**Effect:** no coins accepted

**Possible cause:** electronics error

**Action to take:**

Switch the power off and then on again. If the fault does not clear, replace the Change giver

### **Amber Flashes x 2**

**Message:** *"AGM error"*

**Faulty module:** acceptor (accept gate)

**Effect:** coins not accepted

**Possible cause:** coin jam or debris in the accept gate area

**Action to take:**

- 1 Open the acceptor and clear the jam
- 2 Check the acceptor gate mechanism is clean and there are no coins holding the gate
- 3 Close the acceptor – be sure to close it fully

**Amber Flashes x 3**

**Error message:** "Separator error x" (x can be A, B, C or D)

**Problem module:** separator

**Possible causes:** coin jam at the top of a coin tube; dirty cassette; cassette not properly in place; dirt on the top-level sensor; cassette not assembled correctly

**Action to take:**

If possible, remove the coin tube cassette, clear the jam and/or clean the sensor, and then replace the cassette

If you cannot remove the cassette, the cause is likely to be a coin jam at the top of a tube. To free the jam:

- 1 Remove the Change giver
- 2 Lay the Change giver on its back until the jammed coin slides back into the separator. You can then remove the cassette to check there are no other jammed coins
- 3 Check the screws at the top of the coin tubes are fully tightened
- 4 Clean the top-level sensor if necessary
- 5 Reinstall the cassette
- 6 Reinstall the Change giver

**Amber Flashes x 4**

**Error message:** "Dispenser error.x" (x can be A, B, C or D)

**Problem module:** dispenser

**Effect:** no change given; faulty tube is usually disabled

**Possible cause:** coin jam at the bottom of the indicated coin tube; loom incorrectly fitted

**Action to take:**

- 1 Remove the coin tube cassette
- 2 Free the jam
- 3 Check the loom is fitted correctly
- 4 Press the **Mode** key twice to park the dispenser arms
- 5 Replace the cassette

**No LED On**

If the LED on the keypad does not come on at all:

- 1 Visually check the power supply to the vending machine – there may be a power-on light or other indication



If there appears to be a power supply problem, tell the operator to contact an electrical service engineer

- 2 Check the cable connection between the Change giver and the vending machine is secure

If the vending machine has power, and the cable connection is satisfactory, the Change giver fuses may be blown - see the following section.



## Fuse Replacement

- 1 Remove the cassette
- 2 Lower the acceptor/separator - steps A and B below
- 3 Push the fuse cover downwards to unlatch it and then pull it forward – step C

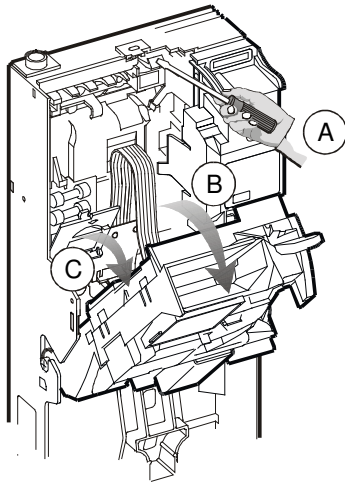

- 4 Replace the fuse(s)
- 5 Close the fuse cover
- 6 Replace the acceptor/separator
- 7 Replace the cassette

*This page is intentionally blank*

# Changegiver Replacement

## Before You Begin



- 1 **TURN OFF THE POWER SUPPLY TO THE VENDING MACHINE**
- 2 Check the voltage of the replacement Changegiver is the same as the vending machine voltage

## Removing

- 1 Disconnect all the cables connecting the Changegiver to the vending machine – there may be comms and display cables as well as the electrical cable
- 2 Undo the single retaining screw, right-hand position
- 3 Lift the Changegiver off the location screws or studs

## Installing

- 1 Locate the Changegiver on the screws or studs
- 2 Replace the retaining screw

### Installation Checks

- 1 Check there is clearance at dimension X. The Change giver lever must be able to lift to its fully open position
- 2 Check the alignment of the coin chutes. Insert two coins of each type into the vending machine and check that they cleanly enter the Change giver acceptor and exit from the Change giver into the cash return cup

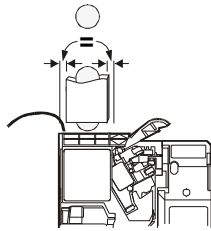
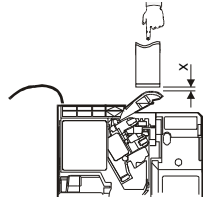

### Connecting

- 1 Plug in the power cable. Only one of the end connectors will match the socket on the vending machine. If there are sockets for comms and display cables, there will be cables with matching connectors fitted to the Change giver. Plug them in
- 2 Tuck the unused cables away tidily. Make sure they will not be trapped when the vending machine door is closed
- 3 Switch on the power and check that the keypad LED settles to green. If it does not, refer to *Fault Finding* on page 9.

# Module Replacement



**BEFORE YOU REMOVE ANY MODULE, TURN OFF THE POWER SUPPLY TO THE VENDING MACHINE.**

## Coin Tube Cassette

### Removing

Press the blue tabs together and then lift the cassette outwards and upwards – steps A B and C below

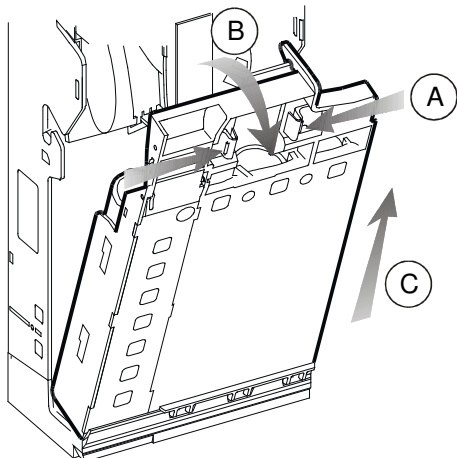

### Installing

- 1 Check that the white dispense arms at the bottom of the Change giver are

engaged in their guides, as far forward as they will move. If they are not, carefully ease them forward

- 2 Locate the cassette in the bottom of the Changer and then gently push it at its upper end until both clips click into position

## Acceptor/Separator

### Removing

- 1 Remove the coin tube cassette
- 2 Disconnect and remove the acceptor/separator – steps A B C and D below

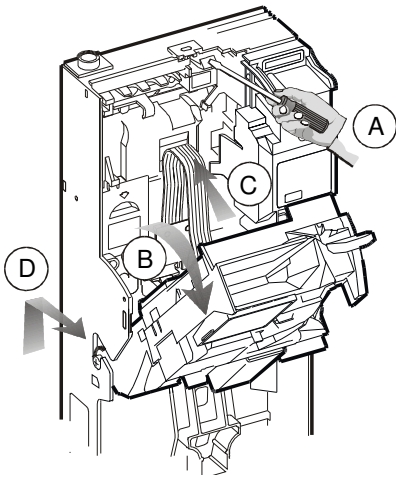

*Installing*

- 1 Reposition the acceptor in the hinge slots
- 2 Plug in the loom to the back of the acceptor
- 3 Push the acceptor back until it clicks and locks in position
- 4 Replace the coin tube cassette

**Keypad Assembly***Removing*

- 1 Remove the coin tube cassette
- 2 Remove the acceptor/separator

- 3 Unplug the loom A connecting the keypad to the printed circuit board and remove the keypad fixing screw B

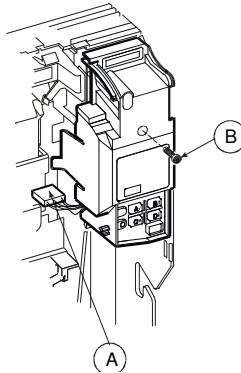

- 4 Tilt the keypad assembly outwards, unplug the display loom, and then lift upwards to unhook the lower retaining lugs from the spine – steps C, D and E

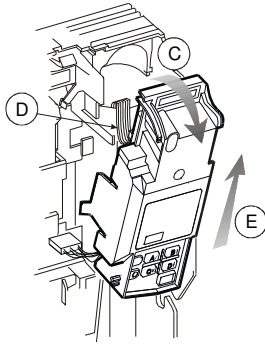

#### *Installing*

- 1 Connect the loom to the display PCB
- 2 Hook the lower end of the assembly into the recesses in the spine and then push it forward into position
- 3 Replace the retaining screw
- 4 Plug in the loom attached to the keypad assembly into the PCB
- 5 Replace the acceptor/separator
- 6 Replace the cassette

#### **Transformer**

**Note:** The following applies to Electro Mechanical Changeovers only..

#### *Removing*

- 1 Remove the coin tube cassette
- 2 Remove the acceptor/separator assembly
- 3 Remove the keypad assembly



- 4 Disconnect two looms, one connecting the transformer to the PCB alongside the transformer housing, the other to the PCB under the fuse cover – steps A and B below. Then lift the transformer C out from its housing

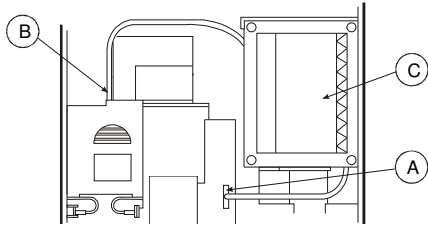

#### *Installing*

- 1 Place the transformer in its housing
- 2 Plug in the two looms – one to the PCB alongside the transformer housing and the other to the PCB under the fuse cover
- 3 Replace the keypad assembly
- 4 Replace the acceptor/separator assembly
- 5 Replace the coin tube cassette

## Dispenser

### Removing

- 1 Remove the coin tube cassette

- 2 Unplug the loom A connecting the dispenser to the interface PCB

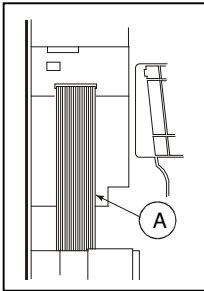

- 3 Carefully spring the spine moulding slightly outwards to release the two lugs holding the dispenser in position and slide the dispenser out – steps A B and C

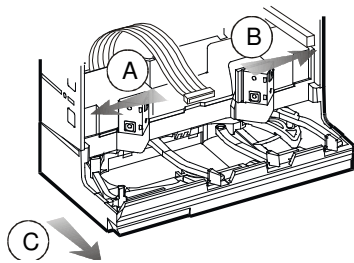

*Installing*

- 1 Locate the dispenser in the runners at the bottom of the spine, and press it gently forward until it clicks in position. Check that the lugs holding it are at each side are fully engaged
- 2 Connect the dispenser loom to the interface PCB
- 3 Check that the white dispenser arms at the bottom of the Change giver are engaged in their guides as far forward as they will move. If they are not, carefully move them forward
- 4 Switch on the power to the vending machine
- 5 On the keypad, press the yellow **Mode** key twice to park the dispenser arms. When they are parked they should be fully located in the coloured inserts at the bottom of the coin tube cassette
- 6 Replace the coin tube cassette

*This page is intentionally blank*

# Service Procedures

In the following procedure diagrams:

 = the Mode key

## Float

### Float Up

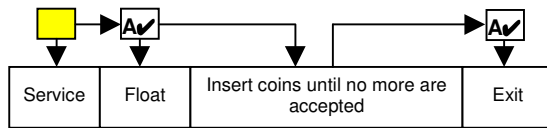

### Float Down

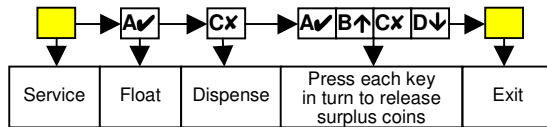

### Float Teach

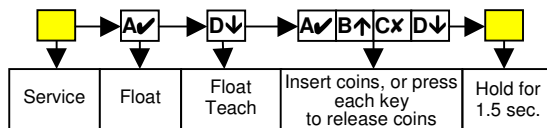

### Float Reset

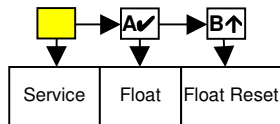

## Configure

### Enable or Inhibit a Coin

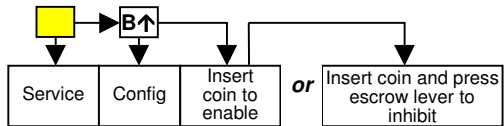

### Show Channel Details

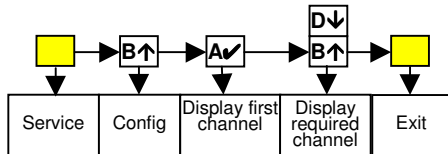

### Select a Euro Transition Stage (1 to 4)

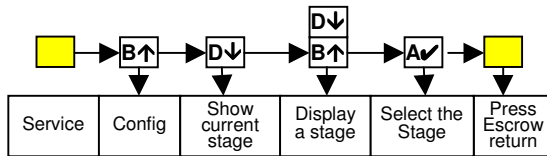

## Price Teach

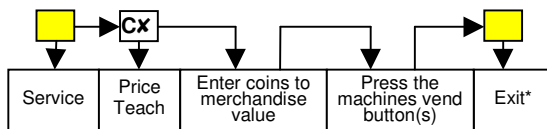

*\*Alternatively, press escrow return to exit*

### Cassette Set

#### Group 1 Cassette

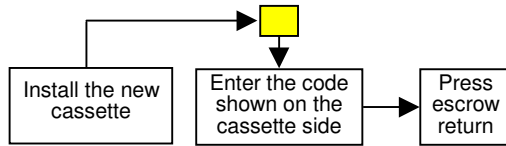

#### Group 2 Cassette

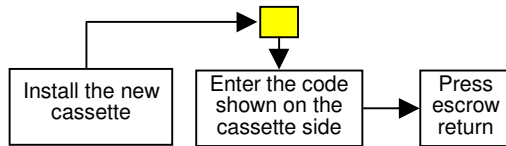

#### Customise a Cassette

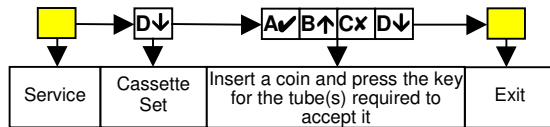

### Audit

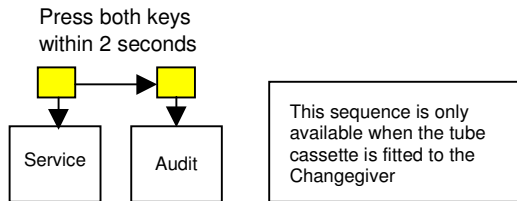

## Manually Filled Coin Tube

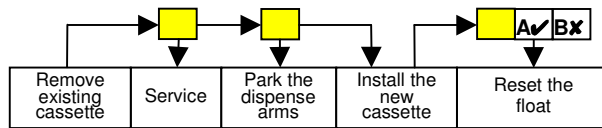

## Empty the Coin Tubes

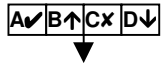

Press and hold each key in turn for at least 3 seconds to latch the key and start dispensing coins. All the coins with the exception of the 'safe count' will be dispensed. Press each key again to unlatch them. To dispense the safe count, press all the keys again. To dispense a single coin, press the key once, quickly. The coin count is shown on the Change giver display



# Setup Procedures

This section includes an overview of the configuration changes you can carry out using the Setup mode.

## Procedural Overview

The following generally applies.

- 1 Enter the **Setup** mode – press the **Mode** key for at least 1.5 seconds
- 2 Select a Change giver variant (when applicable) – press **B↑** and **D↓** to scroll through the list and then press **A✓** to make a selection
- 3 Select a function - press **B↑** and **D↓** to scroll through the list and then press **A✓** to make a selection
- 4 Choose an option or select a value - press **B↑** and **D↓** to scroll through the list and then press **A✓** to make a selection
- 5 **Exit** – press the **Mode** key

## Setup Configuration Options

### *Functions and Variants*

The following table lists the Setup mode configuration options in alphabetical order and for each one shows the variant(s) and configuration function to which it applies.

<b>Setup Option</b>	<b>Function/Variant</b>
Acceptance	
Award Discount	Setup – BDV Config
Change Configuration	Cassette Payout - Coin Cfg
Change Delay	Setup - EM, EXEC and BDV Config
Change Installation Date	Audit Cfg
Change Configuration	Cassette Payout
Coin Scaling Factor	Setup - MDB Config
Coin Setup	Coin Cfg
Country	Setup
Currency Conversion Factor	Bill Cfg, Card Cfg
Currency National	Coin Cfg
Decimal Point Position	Setup
Dispense To	Cassette Payout
Escrow Return	Setup - EM, EXEC and BDV Config
ExC Algorithm	Setup - EM Config
ExC Equation	Setup - EM Config
ExC Inhibits	Setup - EM Config
ExC. Offset	Setup – EM Config
Fill To	Cassette Payout
Float Report	Setup - MDB Config
Hardwire Protocol	Audit Cfg
Highest Value to Accept	Bill Cfg

<b>Setup Option</b>	<b>Function/Variant</b>
ID 101 VMC Indent	Audit Cfg
Keypad	Setup
Link Master ID	Setup - EM Config
Loom	Setup - EM Config
Maximum Card Credit	Card Cfg
Maximum Change	Setup - EM Config
Maximum Credit	Setup - EM, EXEC and BDV Config
Maximum Total Bill Credit	Bill Cfg
MDB Level	Setup - MDB Config
Reset Mode	Setup - EM Config
Overpay	Setup - EM, EXEC and BDV Config
Overpay Amount	Setup - EM, EXEC and BDV Config
Price Display	Setup - EM, EXEC and BDV Config
Price Hold	Setup - EM Config
Print Language	Audit Cfg
Print Logo	Audit Cfg
Report Style	Setup - MDB Config
Reset Audit Data	Audit Cfg
Mode	Coin Cfg
Reset Optical Password	Audit Cfg
Revaluation	Card Cfg
Select Report	Audit Cfg
Set Active Cassette	Cassette Payout
Set All Prices	Prices
Set Custom Cassette	Cassette Payout
Set Group	Cassette Payout

Setup Option	Function/Variant
Set Price Line	Prices
Settings	Setup
Trigger Discount	Setup - BDV Config
Tube Configure	Cassette Payout
Vend Type	Setup - EM, EXEC and BDV Config

### Configuration Options

The following table provides an overview of the options associated with each configuration option

Setup Option	Configuration Options
Acceptance	Nat – National currency (National) Nat+EU – National currency and the Euro EU – Euro (Euro)
Award Discount	Zero or a value
Change Configuration	Select a channel
Change Delay	Time of 1 to 250 sec 1 to 250 sec in 1 sec increments,
Change Installation Date	Enter a date
Channel Configuration	Select a channel and then make active or inhibit
Coin Scaling Factor	Auto (will show "Auto (x)" where x is the value being used which is computed by the system. This is the recommended setup) Factor (in the range 0 –255)
Coin Setup	Set value of each coin
Country	Enter a telephone code

Setup Option	Configuration Options
Currency National	Mode BDA – National currency only (Cassette Payout must be Euro) Mode BDB – National currency plus the Euro; credit in national currency (Cassette Payout must be Euro) Mode BDC – National currency plus the Euro; credit in Euro (Cassette Payout must be national) Mode BDD – Euro only (Cassette Payout must be national)
Currency Conversion Factor	Normally this is set to 1. Thus the displayed value = CCF x value of the card or bill
Decimal Point Position	Nat Euro
Dispense To	Empty level Safe level
Escrow Return	Yes or No
ExC Algorithm	BDV (details are set manually) CF690 (recommended – automatically calculated)
ExC Equation	Select a number in the range 0 – 255
ExC Inhibits	Select a coin(s)
ExC. Offset	Select a number in the range 0 – 255
Fill To	Max Fill Level or Float Level
Float Report	On or Off
Hardwire Protocol	Select an option
Highest Value to Accept	Enter the highest value bill that can be accepted, eg £10 in the UK, shown as 10
ID 101 VMC Indent	View. Clear, Modify

Setup Option	Configuration Options
Keypad	Enable or inhibit the following options: Basic (Dispense, Float) Mode B (Changer Options) Mode C (Price Teach) Mode D (Cass Teach) Soft Option Menu
Link Master ID	Select a number in the range 0 – 65534
Loom	Standard or make T4 = T3
Maximum Card Credit	Enter an amount
Maximum Change	Enter an amount
Maximum Credit	Enter an amount
Maximum Total Bill Credit	Enter an amount
MDB Level	Lvl 2 Lvl 3 No Feat (no features, that is, as Lvl 2) Lvl 3 All Feat (all features, that is, it supports the MDB alternative payout - recommended setting)
Mode	High Acceptance or High Security
Overpay	Retained or Cleared
Overpay Amount	Enter an amount
Price Display	Yes or No
Price Hold	Changer or VMC
Print Language	Spanish, Dutch, German, French, English
Print Logo	View, Clear, Modify

<b>Setup Option</b>	<b>Configuration Options</b>
Report Style	CF Inc Safe CF Hide Safe (recommended option) TRC Inc Safe TRC Hide Safe
Reset Audit Data	No Reset – all data is retained Interims Reset – interim data is cleared Totals Reset – totals are cleared Int and Tot Reset – interim data and totals are cleared
Reset Mode	Blk reset (EU) 30ms Delayed blocker reset (EU) (EU = European) 200ms Delayed blocker reset (EU) Blk hold reset (EU) Escrow accept (EU) US 1 Price (TRC6800) (1-price pulsed output, ignores blocker and simulates permanent sense) MC5807 Blocker, 2s (US) (not used in Europe)
Reset Optical Password	Confirm - the password is reset and can be used Cancel – password is not reset
Revaluation	Yes or No
Select Report	Free Vnd Interims Basic
Set Active Cassette	Select a cassette or enter a code
Set All Prices	Enter a price
Set Custom Cassette	See Engineer's Handbook

Setup Option	Configuration Options
Set Group	Select a group
Set Price Line	Enter a price
Settings	Save or Restore
Trigger Discount	Zero or a value
Tube Configure	<p>Full – the number of coins that can be stored before the top level sensor is covered and coin tube registers as being full, eg 100</p> <p>Max – the maximum number of coins that will be saved to a tube, eg 100</p> <p>Flt – the number of coins to be held as a float</p> <p>Low – the number of coins in coin tube when the low level sensor becomes uncovered</p> <p>Safe – the number of coins that must always remain in coin tube, eg 2, to ensure correct dispense operation</p> <p>Weight – the number of coins left in a tube that will trigger the software to look for alternative payout coins, eg 50</p> <p>Designator – the designator allocated to coin tube A, B, C or D (for information only)</p> <p>Tube Type – for information only, no setting required</p> <p>Scroll through the options and complete all the configuration before you exit</p>
Vend Type	Single or Multi



## Product support

In addition to the MEI offices around the world, an international network of Distributors and Approved Service Centres can offer you technical support and other services as well.

These services include repairs, re-programming of your CashFlow<sup>®</sup> products with new coinsets, replacing damaged modules, and the supply of a range of spare parts.

**[WWW.MEIGROUP.COM](http://WWW.MEIGROUP.COM)**